

# radio service dealer

## Watch! Radio Appliance TIME TABLE

COOKER OVER FIRE	EE HEATING RADS	IRONITE MANGERS	DISH WASHERS	DISPOSAL UNITS
VACUUM CLEANERS	SMALL RADIOS	50 BURNER GAS RANGES	HAND VACUUMS	2 DOOR REFRIG
RECORD PLAYERS	HEATING STOVE/GRILLS	ELECTRIC CLOCKS	FLOOR WAXERS	TELEVISION
GAS RANGES	THE ALL NEW PINKNEY	ELECTRIC IRONS	ELECTRIC REFRIGERATOR	BRANDY WASHING
ELECTRIC RANGES	MAGNAVON	PRESSURE COOKERS	STEAM IRONS	
SUNRAY LAMPS		TAPPAN GAS RANGES	FOOD FREEZERS	
		ELECTRIC SHAVERS	9 CU FT. REFRIGERATOR	
		PRESTO COOKERS	SUNBEAM MIXMASTERS	
			CHROME GAS RANGES	
			TOAST MASTERS	

Kelvinator

1467

Motorola  
auto radio

In This Issue:  
DC CONVERSION  
NEW SERVICE DATA  
FLEXIBLE FINANCING PLANS

# SYLVANIA NEWS

## RADIO SERVICE EDITION

MAY Prepared by SYLVANIA ELECTRIC PRODUCTS INC., Emporium, Pa. 1946

### FREE, AT YOUR SYLVANIA DISTRIBUTOR'S: VALUABLE BUSINESS AND TECHNICAL AIDS

**SYLVANIA  
SERVICEMAN  
SERVICE**

by  
**FRANK FAX**

In case you haven't already taken advantage of the opportunity, Sylvania has a lot of valuable helps for the radio repairman that are *absolutely free*.

They include attractive, customer-catching window displays, interesting booklets on radio care to give to your customers, service hints and many useful technical charts and booklets.

#### GIVE-AWAYS

Now is the time to dress up your windows and invite new customers into the store. Inside, have the complete line of Sylvania tubes to satisfy your customers, the usual snappy service and a pamphlet or two to give away — as a reminder to stop in again.

Every item shown at the right is free (there are many others, some at a nominal charge). Just call on your local Sylvania distributor for your supply, or write to me at Sylvania Electric, Emporium, Pa. And *remember* — to carry the customer's goodwill, carry Sylvania tubes!

**BASE CHART**  
Types and base views of Sylvania tubes

**FOLDER-TAG**  
On radio cleaning

**GIVE-AWAY FOLDER**  
Helps customers understand your repair problems

**"HELPFUL HINTS" BOOKLETS FOR RADIO SERVICING**

**WINDOW DISPLAY**

**COLOR CODE CHART**

**CHARACTERISTICS CHART**  
Characteristics of Sylvania tubes and panel lamps, with tube base views

# SYLVANIA ELECTRIC

Emporium, Pa.

MAKERS OF RADIO TUBES; CATHODE RAY TUBES; ELECTRONIC DEVICES; FLUORESCENT LAMPS, FIXTURES, WIRING DEVICES; ELECTRIC LIGHT BULBS

We tell the LEAR STORY  
over 80,000,000 times



America's leading national weeklies, monthlies and industry trade papers keep up a rapid-fire barrage of advertisements about the new Lear Radios. These ads appear in full color and black and white, in full page space and in half pages.

And altogether, more than 80,000,000 readers will see them.

This is one step in the promotion of Lear Radios. A whole program of supporting material is planned to send people to Lear Dealers eager to see these new radios with the Lear Tape Recorder, the new remote tuning control, the high fidelity FM and the improved short wave.

Rapidly growing public acceptance of Lear Radios is making the Lear Franchise a particularly valuable property. You should have all the details about it. Get them by writing LEAR, Incorporated, Home Radio Sales and Merchandising Division, 110 Ionia Avenue, N.W., Grand Rapids 2, Michigan.

**LEAR  
RADIO**

# Simpson gives new meaning to



## Mutual Conductance Tube Testing

Tube manufacturers consider that a radio tube has reached the end of its usable life when it falls to a certain percentage of its rated value. There has never before been an instrument to test tubes in percentage terms.

But now here *is* such an instrument. The new Simpson Model 330 tests tubes in terms of percentage of rated dynamic mutual conductance—a comparison of the tube under test against the standard rated micromho value of that tube. The colored zones on the dial coincide with the micromho rating or the percent of mutual conductance, indicating that the tube is good, fair, doubtful or definitely bad. Thus, at a glance, you can check the tube against manufacturers' ratings. If, for any reason, it becomes desirable to know the actual value in micromhos, the percentage reading may be easily converted.

Besides this revolutionary new method, Simpson offers you an equally revolutionary switching arrangement. The circuit is so arranged that, even though there are numerous combinations possible, very few switches require moving to test any one tube. Many of the popular tubes are tested in the "normal" position without moving any of the nine tube circuit switches:

There are fourteen push button switches and nine rotating switches of six positions each. These switches provide infinite combinations in tube element and circuit selection. Only a few settings are necessary for the most complicated tube. The tube chart provided is arranged for quickly identifying the tube and setting the controls.

When you have finished a tube test, the Automatic Reset takes over to speed and simplify the next test. Just press the reset button and instantly all switches, both push button and rotary, return to normal automatically!

SIMPSON ELECTRIC COMPANY  
5200-5218 West Kinzie St., Chicago 44, Ill.

# Simpson

INSTRUMENTS THAT STAY ACCURATE

### SIMPSON MODEL 330 MUTUAL CONDUCTANCE TUBE TESTER

1. Size—15½" x 9½" x 7".
2. Case—Sturdy plywood construction, with heavy fabricoid covering, corners trimmed in leather, rustproof hardware — removable cover with slip type hinges.
3. Panel—Heavy molded bakelite, beautiful satin grained finish. All characters, numerals, and dial divisions are engraved and filled in white, insuring long wearing qualities.
4. Meter—4½" rectangular of modern design with artistic four-colored dial indicating good, fair, doubtful, and bad—also "Percentage of Mutual Conductance" scale.
5. Sockets provided for all types of tubes including acorn tube.
6. Neon glow tube incorporated to indicate shorted tubes.
7. New simplified revolutionary switching arrangement (see description at left).
8. The tube chart provided is arranged for quickly identifying the tube and setting the controls.
9. Tests tubes with voltage applied automatically over the entire operating range and under conditions approximating actual operation in a radio set.

Price .....\$98.50

ASK YOUR JOBBER

# radio service dealer

Member Audit Bureau of Circulations  
Covers all phases of radio,  
phonograph, sound and electrical  
appliance merchandising and servicing

VOLUME 7 Number 5

MAY, 1946

## CONTENTS

In & Around the Trade .....	4
Men in the News .....	6
With the Publisher .....	8
New Highs for Radio Parts & Components .....	13
What to Tell Your Television Customers .....	13
Conversion of DC Sets .....	14
Oscillators, Converters & Mixers ..	16
Television and FM Lead-in Lines ...	19
Flexible Financing Plans .....	20
Crowds at Set Showing .....	21
Veteran & Champion Opens Radio & Appliance Store .....	22
New Servicing Data Plan .....	24
Circuit Court .....	25
Living Electronically .....	28
Dealers Merchandise Discs .....	34
Shop Notes .....	36
The Cover: Dealer "posts" time table of radio and appliance deliveries as show-window background (See also) page .....	20

RADIO SERVICE DEALER (title registered U. S. Pat. Off.) is published monthly at Boston Post Road, Orange, Connecticut, by the Cowan Publishing Corp. Executive & Editorial Offices, 342 Madison Avenue, New York City 17, New York. Publication Office, Boston Post Road, Orange, Conn. Subscription rates:—United States and Possessions \$2.00 for 1 year, \$3.00 for 2 years; elsewhere \$3.00 per year. Single copies: 25c. Printed in U. S. A. Entered as Second Class Matter at the Post Office at Orange, Connecticut, under the Act of March 3, 1879. All subscribers should allow at least three weeks for change of address. Copyright, 1946

COWAN PUBLISHING CORP.  
**SANFORD R. COWAN,**  
Publisher

**LEWIS C. STONE**  
Editor

S. L. MARSHALL, *Asst. Technical Editor*  
Adv. Sales  
J. J. BROOKMAN, H. N. REIZES  
JEAN M. WHEELER, *Circ. Mgr.*  
DAVID SALTMAN, *Adv. Prod. Mgr.*

Branch Offices  
HAROLD J. SUGARMAN, *Western Adv. Mgr.*  
82 W. Washington St., Chicago 2, Ill.,  
ANDover 1395

H. W. DICKOW, *West Coast Advtg. Mgr.*  
1387 40th Ave., San Francisco 22, Cal.

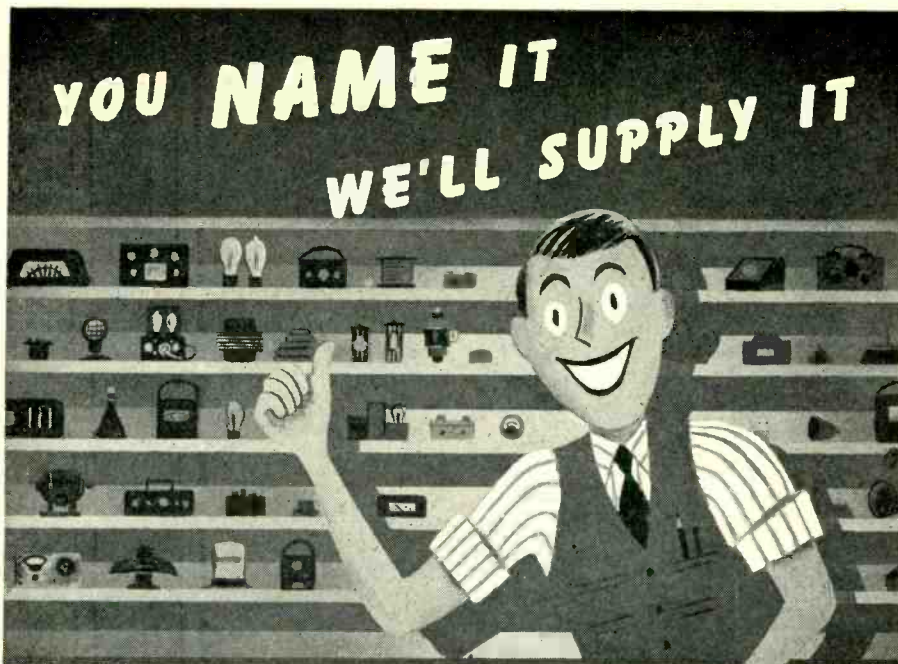

## EVERYTHING IN RADIO AND ELECTRONICS

R. W. T., world's oldest and largest Radio Supply House, is ready again with tremendous stocks of sets, parts and equipment. You can depend on our quarter-century reputation for quality, sound values and super-speed service. Orders shipped out same day received. All standard lines already here or on the way, including: National, Hammarlund, R. C. A., Hallicrafters, Bud, Cardwell, Bliley and all the others you know so well.

## Radio Wire Television Inc.

100 Avenue of the Americas, New York 13 • Boston, Mass. • Newark, N. J.

ORIGINATORS AND MARKETERS OF THE FAMOUS *Lafayette Radio*



**R.W.T.** DEPT. SE6, 100 AVENUE OF THE AMERICAS,  
NEW YORK 13, N. Y.

*I want your big new post-war Catalogue.*

NAME \_\_\_\_\_

ADDRESS \_\_\_\_\_

HAM?  (CALL LETTERS) \_\_\_\_\_

ENGINEER?       SERVICEMAN?       STUDENT?

# In & Around the Trade

Being a condensed digest of production, distribution and merchandising activities in the radio and appliance trade.

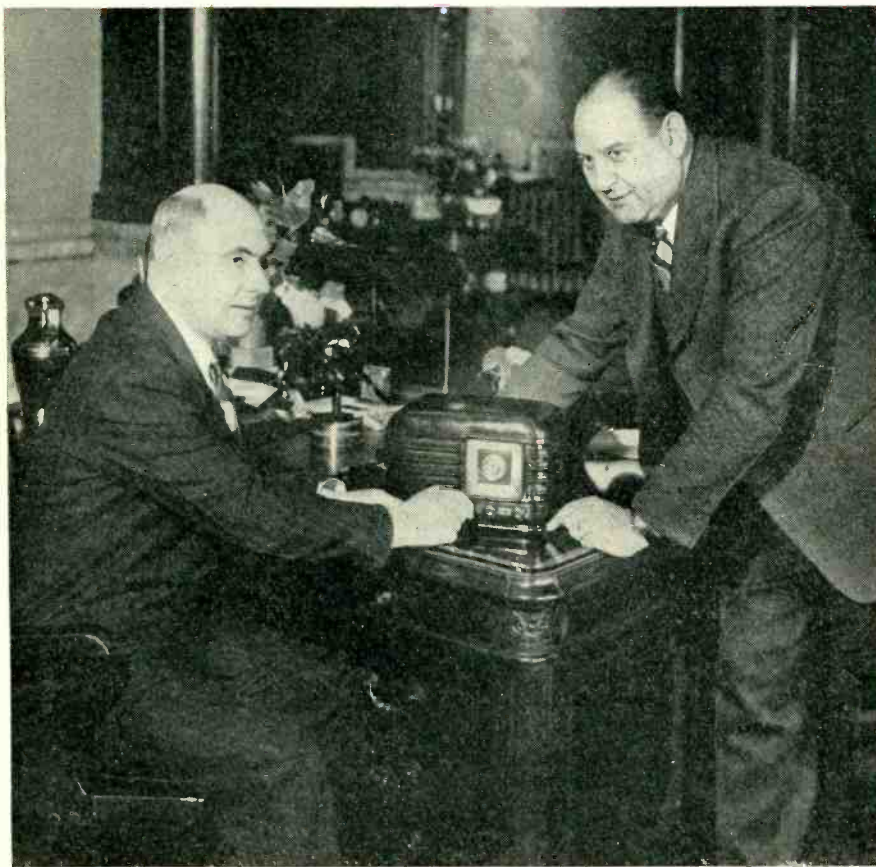

Mayor A. P. Kaufmann of St. Louis (seated) in his office at city hall, tunes in one of the St. Louis radio stations on the first 1946 Crosley radio set to be received in that city. The Crosley was presented by Harvey Frohlichstein (right) vice president, Schwander Appliance Co., Crosley distributors.

## Dealers Protest Tube Prices

**Honorable Chapman Revercombe,**  
**United States Senator**

Dear Senator:

This is a letter in protest of the O. P. A. Radio Tubes Price Policy. Don't think that this doesn't effect you. The fellow that keeps your radio going is the lad that had his income frozen as of Mar. 15, 1942.

Now O. P. A. allows a 20% increase (effective March 15) to the manufacturers of radio tubes (all this was kept in the dark by O. P. A. and the manufacturer until March 19). This price increase is to be absorbed by the service-dealer. The labor income rate has been increased in industry by O. P. A. and government sanction. It is not fair or democratic to help one group at another group's expense. This price policy will cause a reduc-

tion of income for the service dealer. He does not have a flood market of radio tubes such as other commodities have. In addition, O. P. A. price policy slowness has kept radio service material from the market. This lack of material has reduced service dealer income, while overhead has continually increased, through O. P. A. price increases on material he must use. At the same time his major commodities, time and labor, are frozen. The squeeze has been heavy!

We feel this price policy must be corrected. Already much needed and hard to get radio tubes have been stored in the warehouses of distributors to be held until the price situation has been cleared. These tubes in packing cases will not operate radios! Inoperative radios retard the very large business of radio broadcasting.

Remember grass root politics now depend upon radio receivers of the nation. It is up to you to help this situation now, by allowing this price increase to be passed directly to the consumer. The retail price of radio tubes are now still at depression prices. We (The Monongahela Radio Association) represent the majority of the radio service dealers in the Morgantown, Fairmont, and Clarksburg area, but attached we have a copy of signatures that we have collected from the other unaffiliated dealers and service dealers who sell radio tubes in this area.

Now multiply this number by the infinite number of little valleys throughout the United States and you will be staggered by your realization of the gross injustice that this single action of O. P. A. has wrought upon little business men.

It is up to you to act now!

**Drexal McCabe, Clarksburg, W. Va.**  
**Chairman Legislative Committee**  
**Monongahela Radio Association**

## Refrigerator Makers Get Higher Price Ceilings

The retail price of household mechanical refrigerators will be increased on the average slightly over four cents on the dollar as a result of an 8 per cent ceiling price increase allowed to manufacturers by the Office of Price Administration last month. The manufacturers' increase was effective April 18, 1946, and the retail price increase will go into effect as soon as dealers receive refrigerators invoiced to them at the adjusted prices.

The eight per cent increase is the first industry-wide increase granted the refrigerator manufacturers since the end of the war. The adjustment reflects all labor and material cost increases allowable under the new wage-price policy.

Distributors and dealers are allowed to pass on the exact amount of the manufacturers' increase, so that the consumers will pay the current dollar-and-cent ceiling price plus the dollar amount of the manufacturers' price increase.

## 15-Cent Item into \$500,000 Volume

Under the leadership of Julius Finkel, president, JFD has become a world famous organization, supplier of more than 20 essential radio parts to radio jobbers everywhere. In our conversation with him, we tried to hold Mr. Finkel to a discussion of his many products. We thought that radio antennas, resistance cords, ballasts, sockette radio tube adapters, plugs,

[see page 30]

timely!  
authentic!  
comprehensive!



## Save Up to 50% in Servicing Time!

### In Each PHOTOFACT FOLDER You Get:

- ✓ From 2 to 12 clear photos of the chassis, identifying each component part for immediate checking or replacement.
- ✓ Complete specifications on each component, including manufacturer's part number, available replacement type or types and valuable installation notes.
- ✓ A keyed reference alignment procedure for the individual set, with adjustment frequencies and recommended standard connections.
- ✓ Complete voltage analysis of receiver.
- ✓ Complete resistance analysis of receiver.
- ✓ Complete stage gain measurement data.
- ✓ Schematic diagram.

If you think it's going to be easy to service the 1,000 or more radio sets soon to come off production lines, read no further! The Howard W. Sams PhotoFact Service is designed for men who *know* there's a tough time ahead—who need and *want* better service information.

The Sams PhotoFact Service provides such information in the form of reliable, fact-filled, illustrated folders that can save as much as 50% of your servicing time. Every post-war radio is visualized in photographs . . . every part listed and numbered . . . every servicing shortcut and installation fact fully set down! No matter how complicated the set, or how new the components, you have the whole story right in front of you.

You get from 30 to 50 such PhotoFact Folders at a time. The Folders come to

you in handy folios at a cost of only \$1.50 for each group! They cover all new sets as they reach the market.

Think of it! An absolutely fool-proof visual method of giving you the exact information you want, where you want it, when you want it, for as little as three cents per new radio model! And every bit of information is compiled by experts from an examination of the actual receiver itself—*not from standard service data!* The Howard W. Sams PhotoFact Service starts June 15. Reserve your PhotoFact service now!

*Also, Membership in*

### HOWARD W. SAMS INSTITUTE

Answers to hard service problems! Economical shop practices! How to get more customers! These and many other subjects covered by 30 top notch specialists! Complete facts with PhotoFact Folio No. 1.

Cut This Out and Mail It to Your Distributor! If you do not know his name and address, send it directly to Howard W. Sams & Co., Inc. 2924 East Washington Street, Indianapolis 6, Indiana, and we will see that your nearest distributor gets it.

CHECK ONE SQUARE

PLEASE PRINT

- Yes, by all means reserve every issue of the Howard W. Sams PhotoFact Folio Service for me.
- Send complete information and reservation card.
- My (check) (money order) (cash) for \$1.50 is enclosed for PhotoFact Folio No. 1. (Publication date, June 15, 1946)

Name \_\_\_\_\_ Address \_\_\_\_\_

City \_\_\_\_\_ Zone \_\_\_\_\_ State \_\_\_\_\_

Company Name \_\_\_\_\_

My Distributor's Name \_\_\_\_\_ City \_\_\_\_\_



*Howard W. Sams*

# Radio PhotoFact Service

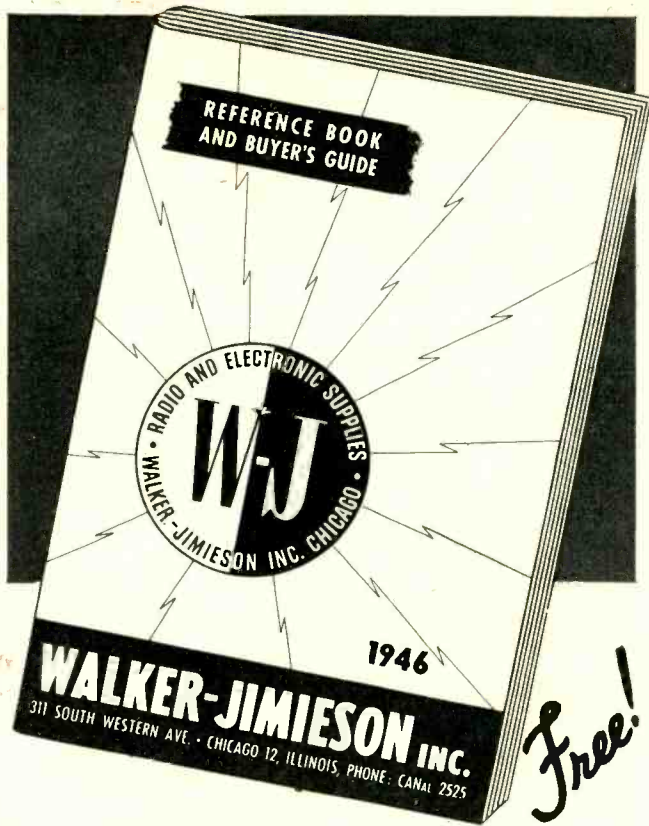

## Get this NEW 1946 *Electronic* Reference Book and Buyer's Guide

**K**EEP pace with newest developments in Radio and Electronic Parts and Equipment! Send for the new and complete 1946 W-J Reference Book NOW! Study its many fascinating pages. Learn about new, modern miracles of Electronics . . . how amazing devices create entirely new profit opportunities for Radio Dealers. This attractive 6" x 9" handy size 100 page book contains a complete listing of over 10,000 radio components, with many illustrations and descriptions.

**WALKER-JIMIESON, INC.**  
 311 SOUTH WESTERN AVE., CHICAGO 12, ILL.  
 Phone **CANal 2525**

Gentlemen: Please send me a free copy of your 1946 Electronic Reference Book and Buyer's Guide.

COMPANY NAME .....

ATTENTION OF ..... Title .....

STREET ADDRESS .....

CITY & STATE .....

## MEN IN THE NEWS

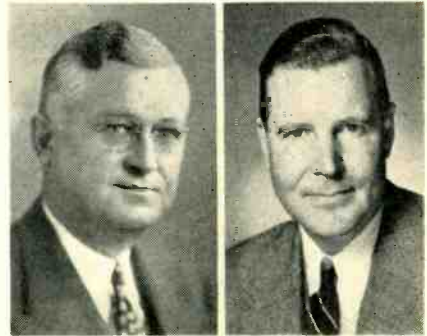

Left: Walter E. Poor, newly elected chairman of the board of directors, Sylvania Electric Products, Inc. Right: Don G. Mitchell, successor as company president.



Samuel J. Novick, who was elected chairman of the board and treasurer of Electronic Corp. of America. Below: Garrard Mountjoy, who was elected president of Electronic Corp. of America succeeding Mr. Novick, Mr. Mountjoy was formerly vice-president in charge of engineering.



### G. E. Appoints Fred Parnell

Fred A. Parnell has been appointed advertising and sales promotion manager for the General Electric Company. [See page 29]



**THE ODDS  
ARE STILL**

**6 to 1**

**AFTER** World War I, no less than 886 different brands of radio sets were offered to the public.

By 1940, no less than 742—83.7 per cent—were discontinued.

They were orphans.

Of course, no one—dealer or customer—wants a prospective orphan, but the odds are still 6 to 1 that the average buyer will choose just such a set.

One way *you* can be sure of good will and good business—not just for the moment, but for years to come—is to sell a radio line that you know *won't* become an orphan.

Stewart-Warner is such a radio, and has been for 22 years. The world-famous \$50,000,000 Stewart-Warner institution guarantees it.

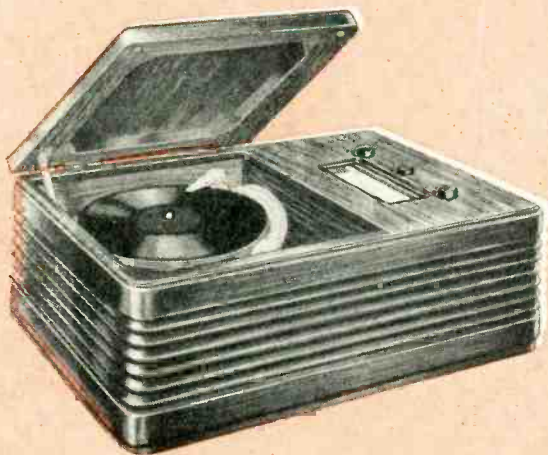

**Stewart-Warner Table Radio-phonograph**—a triumph of advancement in radio and record reproduction! Tamper-proof record changer plays up to 12 records. Tone you'd expect only in a big console. And 4 screw-in-type legs make this model into the consolette.



**Strobo-Sonic  
TONE**

... so faithful you can distinguish every instrument, understand each word, hear music in its true dimensions, picture-clear. A revelation in radio-listening pleasure! An exclusive Stewart-Warner feature.

**THESE GREAT FEATURES MEAN  
THE BEST FOR YOU**

**Radair Antenna**—actually repels annoying static; brings in even the weakest signals.

**Signal Sentry**—bars the hum and sizzle, helps bring in the most distant stations.

**Selectivity and Sensitivity**—now 60 per cent improved over prewar models.

**Strobo-Sonic Tone**—living-room performance with concert-hall reality. Exclusive!

**MORE THAN EVER, YOU CAN DEPEND ON**

**Stewart-Warner**

*Radios  
Radio-phonographs*

**CHICAGO 14**





A properly planned sound installation is a good investment and soon pays for itself. Practically all industrial firms use, or plan to buy, some type of P-A or paging installations.

The majority want RACON speakers and driving units because they have proven to be the finest that money can buy.

RACON receiver units are supplied with either metal or plastic diaphragms. RACONS outperform higher power-rated speakers of other manufacture, yet cost no more and afford peak efficient, dependable service over a longer period of time. Specify RACONS! There's a speaker, horn or driving unit for every purpose. Literature will be sent upon request. Hand prospective P-A buyers our catalog — they'll "OK" RACONS.

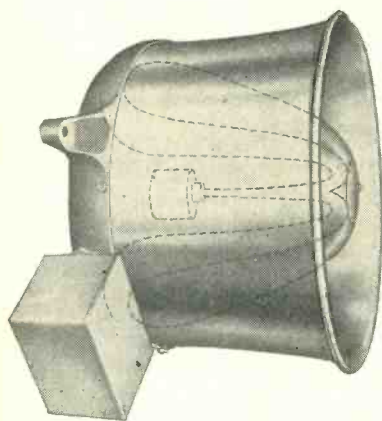

**MARINE SPEAKER:** approved by the U. S. Coast Guard, for all emergency loudspeaker systems on ships. Re-entrant type horn. Models up to 100 watts. May be used as both speaker and microphone.



**P.M. HORN**  
P.M. Horn units are available in operating capacities of 5 to 50 watts.



**AEROPLANE HORNS;** super-powerful and efficient P. A. horns for extreme range projection. 9-4 and 2 unit Trumpets available.

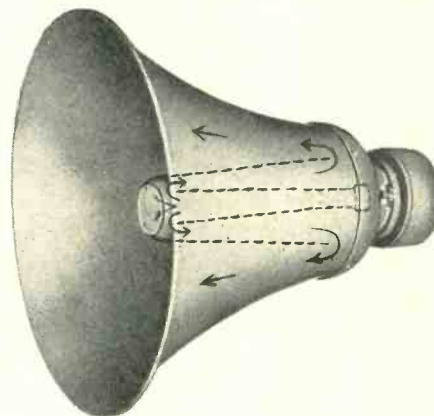

**RE-ENTRANT TRUMPET;** available in 2½-3½-4½-6 ft. sizes, Compact. Delivers highly concentrated sound with great efficiency over long distances.

**RACON ELECTRIC CO., INC. 52 EAST 19th ST. NEW YORK, N. Y.**

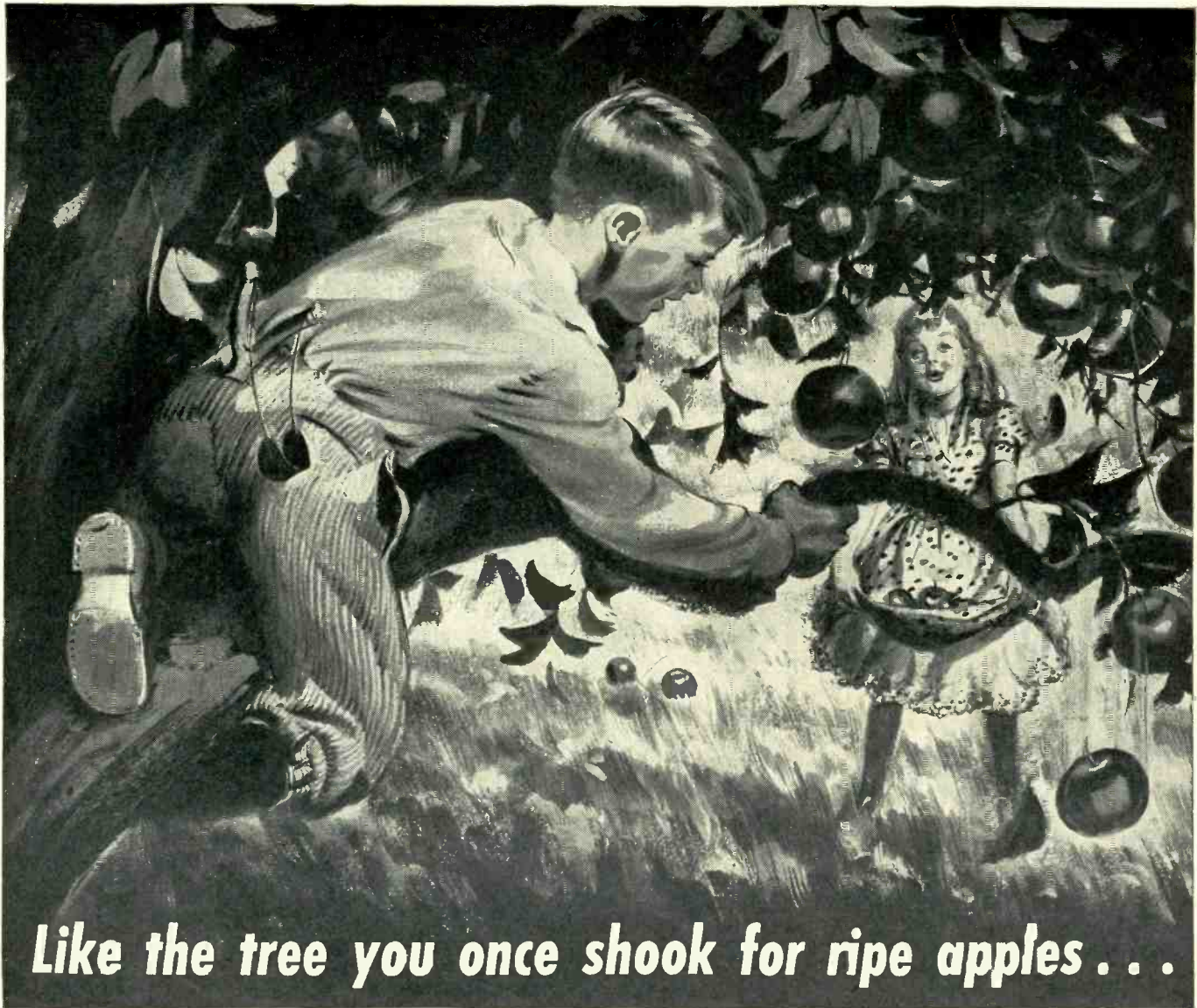

**Like the tree you once shook for ripe apples . . .**

**A PROFIT-laden market  
awaits dealers who handle**



**RADIO TUBES**

**T**HE juicy winesaps in grandfather's sunny orchard were no finer or more plentiful than the profit opportunities from today's market for G-E radio tubes! Demand is the biggest in history. YOU, as a G-E dealer, can get the lion's share of this business, because you handle the brand which an overwhelming majority of radio owners know, respect, and will buy.

Magic of the G-E monogram, famous symbol of quality, draws purchase-dollars from a public already familiar with G-E lamps, fans, refrigerators,

irons and other appliances, as well as radios and tubes. Your market for tubes is *pre-sold* on the G-E brand! And tremendous national G-E electronics advertising — in magazines with 30,000,000 circulation—boosts the demand still higher! Write for information on tube selling rights to *Electronics Department, General Electric Company, Schenectady 5, N. Y.*

Every tube dealer and service man should have G.E.'s Tube Characteristics Booklet ETR-15. Send for your free copy today!



**GENERAL  ELECTRIC**

176-E3-8000

FIRST AND GREATEST NAME IN ELECTRONICS

# MAKING TUBES IS EASY...

## If YOU KNOW HOW!

HOW HYTRON CATHODE COATINGS ARE MADE

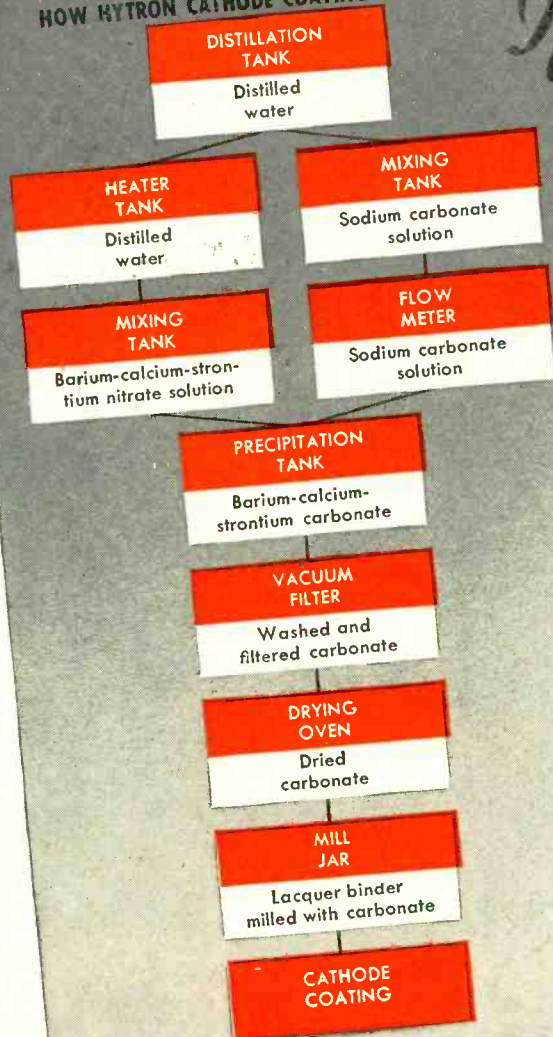

First floor of Hytron chemical precipitation system. Note the flow meter, precipitation tanks, and ceramic vacuum filters. Spotless cleanliness is vital to avoid contamination of carbonates precipitated for cathode coatings.

## AGAIN HYTRON KNOW-HOW WORKS FOR YOU...

**T**HIS photograph and flow chart may look strange in an advertisement on radio tubes. Chemistry and metallurgy, however, are a vital part of Hytron engineering. The picture illustrates the first of three floors used by Hytron's chemical system which precipitates the carbonates for cathode coatings.

Prewar, Hytron purchased such carbonates—as did most other tube manufacturers. Wartime mass production demanded much better quality control than suppliers offered. By doing the job itself, Hytron gained extra know-how which serves you in peacetime.

For these carbonates, absolute control is required of formulation, crystal size and shape, density, purity, and

viscosity. Most cathode coatings are prepared from carbonates compounded of barium, calcium, and strontium. The percentage of each of these elements affects the performance of different types of tubes. Crystal size and shape, density, freedom from impurities, all determine the degree of electronic emission. Variations in viscosity must be minimized to assure uniform application of coating on the cathode.

There is still much "black magic" in obtaining proper cathode emission. But Hytron makes easier the problems involved by accurate chemical and metallurgical controls. No research is too tough or too unrelated, if it leads to know-how which will give better performance of the Hytron tubes you buy.

OLDEST MANUFACTURER SPECIALIZING IN RADIO RECEIVING TUBES



# HYTRON

RADIO AND ELECTRONICS CORP.

MAIN OFFICE: SALEM, MASSACHUSETTS



# New Highs for Radio Parts and Components

**A** BUSINESS volume of \$150,000,000 at the consumer level may be expected by the radio parts manufacturing industry for 1946 in the light of expected demands and probable production. This is actually a conservative estimate considering that the industry did \$125,000,000 worth of business during 1945. The outlook for radio parts manufacturers will become increasingly brighter as production gets on a firm footing. Once we get up full steam, it is almost impossible to estimate the volume of business that we can ultimately expect; certainly from all indications it will run well over the \$200,000,000 figure in 1947.

Demand for radio parts and equipment, already high, will be eclipsed when new products and inventions, many of them already in the production planning stage, hit the market. Just what the future holds for American consumers in the field of invention will probably make Jules Verne and his once fantastic ideas look conservative. Fantastic is too mild a term for what may be in store once the fields of electronics, frequency modulation, plastics, radar and television—to mention only some of the newer advancements—are more fully explored.

Some of the commercial uses to which radar, sonar, and infra-rays can be put have already been announced. The possibility of equipping automobiles with radar, and automatic stopping devices to eliminate collisions, is close to application and its installation on planes and ships is under way. Speaking of infra-rays, the recent prison break attempted at Alcatraz could have been a fine demonstration of the use of the war-developed "sniperscope", which would enable law-enforcement officers to see clearly at night without visible light.

In the field of electronics, we have already perfected the electronic computing machine, which had considerable publicity recently. Its application to office machines should be readily adaptable. The home and office of tomorrow will probably be equipped with electronic comptometers, calculators and other such devices which will automatically make all book-keeping methods of today completely obsolete and the wire or tape recorders will probably eliminate all other types

**Expanding markets for radio servicemen and technicians here today.**

**By H. W. CLOUGH\***

of voice recording devices. The housewife can let electronics simplify all her budget difficulties at the cost of a few cents' worth of electricity.

The combination of frequency modulation and color television probably will be one of the most dramatic applications during the next few years. Although the present difficulties concern transmission, the solution is only a matter of time. Quite probably it will lie in piping television through something new in the cable field, at least this seems the most probable today. Such a television cable could make televised programs available on a coast-to-coast network without the earlier suggestion of relay stations, or the plan for a fleet of strato-planes.

Another problem, whose solution seems imminent, is in the field of radio frequencies and micro-waves. Once the problem of "beaming" radio waves

*\*Vice-President of Belden Manufacturing Co., President of the Radio Parts & Electronic Equipment Shows, Inc.*

along a narrow, disturbance-free channel is solved, every home and car can be equipped with the equivalent of a "walkie-talkie." And similarly, combining the idea of stamped radio circuits with this type of application, it is quite reasonable to imagine a small pocket radio, no larger than a compact or cigarette case, which would enable everyone to be in radio contact with some geographical region at all times. Think of what this would mean to aviators forced down in some remote spot, for people lost in the woods, or just for entertainment purposes. In the field of medicine we already have the electronic stethoscope. Is the electronic microscope and electronic surgery just around the corner?

The entire world is concerned at the moment with a way to counteract the atomic bomb. Although methods for detection and destruction before an atomic bomb can reach its destination are as yet purely in the speculative stage, possibly the solution to such a problem lies in the field of radio frequencies. Since the bomb is at all times radio-active, something to detect such radio activity at great distances and then to explode the bomb before it can accomplish its mission lies within the realm of possibility.

## WHAT TO TELL YOUR CUSTOMERS ABOUT TELEVISION

by E. A. NICHOLS

*President, Farnsworth Television & Radio Corp.*

**T**HE YEAR ahead is destined to be one of marked progress in the bringing of finer living and new comforts to American homes through television and radio.

Probably the postwar electronic news of greatest import to the American public is that highly improved home television is at hand. *Visual radio is no longer an embryo in the laboratory. It is technically ready to go forward on a commercial basis as soon as transmitters can be installed and receivers distributed. Television has reached a point of maturity at which its established sponsors can present it to the public with confidence and pride.*

*This is not to imply that television has achieved its ultimate state of perfection. Television, like radio and every new development, remains open to improvement. However, this improvement—as in radio—will be a gradual process, taking place over a period of years. Therefore, the purchaser of a 1946 television receiver need have no fear that this investment will be jeopardized by early obsolescence of his set.*

*The next major improvements, which may well include an all electronic color system of broadcasting, are likely to be many years in development before they meet the requirements of practical use.*

# CONVERTING DC SETS

**Converting DC sets is not difficult. In some cases, results are long on experience, rather short on profit. This article will help remedy the situation.**

by S. HELLER

**A**LTERNATING current is standard in most parts of the United States. The reasons for this lie in the following advantages that the use of ac offers: Voltage can be stepped *up*, which permits low cost transmission of power. In power packs, this voltage step-up takes care of high voltage plate requirements. Voltage can be stepped *down*, to accommodate low voltage filament needs. Direct current, on the other hand, can neither be stepped up or down, and must be used at the generated voltage. In spite of the superiority of ac to dc, dc generators are still in use in the downtown business districts of many large American cities.

Owners of straight dc sets who move to ac neighborhoods find themselves with a problem. How can they get their radios working? Radio servicemen who are called in for consultation may recommend a converter, or undertake to rewire the set for operation on ac, or ac-dc. They may also, because of inadequate knowledge, turn the customer away. This article is intended to eliminate the last course of action.

Converters offer the simplest, quickest means of operating a dc radio on an ac power supply. The following disadvantages, however, must be taken into consideration:

First, it is at present very difficult to obtain a converter that will change 115 v ac to 115 v dc.

Second, these converters are expensive.

Third, rotary or motor-generator type converters (which are the most practical for our requirements) produce considerable noise during operation, and must be tucked away in a closet, or some sound-proof place, if comfortable radio reception is to be enjoyed.

Fourth, when a converter is used to operate a sensitive radio receiver, special filtering units must often be added. This means extra expense.

If a converter is to be used nevertheless, its volt-ampere rating should be considered. The volt-ampere rating is the same as the watts rating, with a unity power factor load, such as a

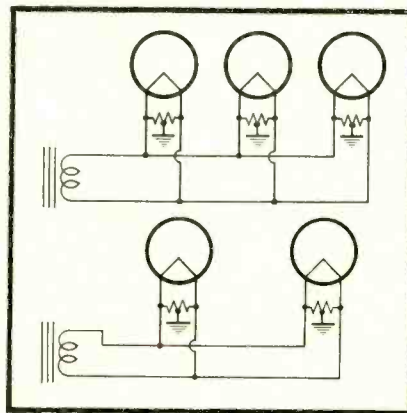
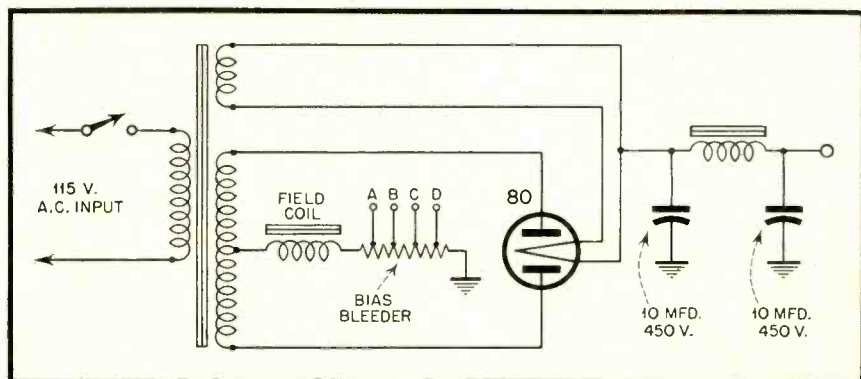

**Figure 1. Placing low-ohm wire-wound resistors across direct-filament tubes and center-tapping them to ground will eliminate hum.**

lamp load. Since the power factor of radios and amplifiers is not unity, but about 85%, a radio consuming 85 watts will draw about a 100 volt-amperes. A 225 volt-ampere converter should take care of any home radio receiver on the market.

If it is decided to rewire the set, rather than use a converter, two procedures are possible: 1. The dc set may be redesigned to work on ac only—in which case the owner will face another conversion problem if he ever moves back to a dc neighborhood. 2. The set may be rewired to work on ac-dc. This would remove the last-mentioned objection.

**Figure 2. Suggested bias arrangements in rewiring DC sets for AC operation.**



A formidable obstacle, present in cases where direct-filament tubes are used, would be the necessity of changing all the tubes and associated circuits. This would be required, unless extremely expensive choke and filter arrangements were provided, to eliminate the loud ac hum that the filament-cathodes would introduce.

When the tubes are wired in parallel, as in a conversion to straight ac, a solution to this problem is possible, as will be described later. When they are in a series ac-dc hook-up, however, the solutions are impractical.

## Straight AC

Let us assume our dc set has direct filaments. Conversion from dc to straight ac seems the best procedure. How shall we go about it?

First, the power supply circuit has to be changed. A power transformer will have to be added. The choice of one will of course depend on the tubes used in the set. One tube—preferably the 2nd a.f.—is generally eliminated, to make room for the full-wave rectifier which has to be added.

Here, here, hold on, we can visualize our readers interrupting at this point. What about the awful hum you are going to get by using dc filaments on an ac supply? Right you are—only we are going to eliminate that hum by putting resistors across the filaments, and center-tapping them to ground (see Fig. 1). This keeps the cathode-filaments at a fixed potential

toward chassis or common ground, and thus reduces hum.

On 1½ and 2½ volt tubes this method should be effective; but on 5-volt types hum may not be reduced as much as desired. Substitution of indirectly heated tubes is recommended in these cases. The resistors used should be low-ohm wire-wound units. In this case, 30 ohms would be about right. They should be connected directly at the filament terminals, to insure correct centering.

Biasing arrangements will be briefly indicated, rather than described in detail. A bleeder resistor unit may be inserted in the rectifier plate to ground circuit, as shown in Fig. 2, and tapped at appropriate points—say at A, B, C and D—to give the required negative grid bias. The speaker field may also be inserted in series with the rectifier plate to ground.

Mounting the power transformer may call for some thought. One of the big choke containers can be removed to make room for the transformer, since the dc chokes are not going to be used. A 30-henry choke and two 10-mike 450 v condensers should be added, as shown in Fig. 2, to complete the rectifier circuit.

### AC-DC

When the dc set to be rewired has indirectly-heated cathodes, an ac-dc hook-up may be made. Let's take the Atwater Kent model 206D as our example. This set uses an 85 as a 2nd detector, 2-78s as r-f and i-f amplifiers, a 6A7 as first detector, and 2-43s in push-pull as power amplifiers (see Fig. 3).

Regarding the power supply changes—a half-wave rectifier tube must be added. The choice, of course, depends on the number and types of tubes used in the set. Add up the plate and screen currents of all the tubes, to determine the dc output current the rectifier must supply.

Figure 3. Simplified power supply and filament circuit, Atwater Kent model 206D.

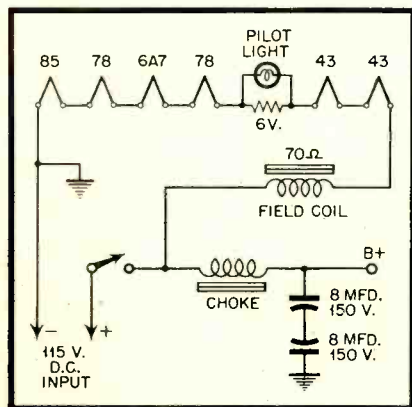

In the case of the Atwater Kent 206D, the plate and screen currents are as follows:

Tube	Plate Current	Screen Current
85	8 ma.	.....
78	10.5 ma.	2.6 ma.
78	10.5 ma.	2.6 ma.
6A7	3.5 ma.	2.2 ma.
43	34.0 ma.	7.0 ma.
43	34.0 ma.	7.0 ma.
	100.5	21.4

The rectifier tube may be externally mounted, if there is no room for it on the chassis proper. Adding up the total plate and screen currents, we get a total of 121.9 milliamperes that must be supplied by the rectifier.

The 35Z5, which is the cheapest of the half-wave rectifiers, would not do, since its dc output current is insufficient. The 25Z5 and 25Z6 tubes, however, supply 75 ma. per plate, or a total of 150 ma., and would thus do very well.

The speaker field may be connected between the rectifier cathode and B plus, if it is 400 ohms or less. When it is greater than 400 ohms, however, such a hook-up will not give the field sufficient energizing current. The B plus voltage will also be pulled down considerably. Decreased volume will thus result.

When the field coil is greater than 400 ohms, it should be connected between one of the rectifier cathodes and ground (use of a 25Z5 or 25Z6 is assumed). The other cathode may be used for the B supply. Sometimes a very heavy winding high-ohm field is present, that is not sufficiently energized by the current delivered by one of the cathodes. Several remedies may be suggested in this case.

The simplest one is to hook the two rectifier cathodes together. This will permit the field to be energized by two cathodes instead of one. The B voltage will fall, since the available dc output current delivered to the plates and screens of the other tubes is decreased. The greater field current, however, should more than offset the tendency to lowered volume produced by the decrease in B voltage.

When this remedy is inadequate, one of two others may be employed. A separate rectifier tube may be added to supply the field current; or a different speaker may be substituted. The conditions of individual cases will control the choice of solutions.

When the field coil is only 600 ohms or so, it may be wise to insert a 5-watt resistor of about 300 ohms in series with it, to prevent the rectifier cathode that feeds it, from delivering

too much current, and thus wearing out prematurely. A choke must be used for the B supply. Dc chokes generally do not have sufficient inductance to be used in half-wave rectifier circuits. A 30-henry choke will therefore have to be added, unless the speaker field is substituted.

A dual 20-20 mfd 150 v condenser should be used to filter the ac on either side of the choke to ground. When one of the rectifier cathodes separately supplies the speaker field, another 20 mfd 150 v condenser will be necessary to remove the ripple in the field current. This condenser is, of course, attached from cathode to ground.

The 8 mfd 150 v condensers found in the dc set may be salvaged, and reused for the ac-dc hook-up. If three 8 mfd units are present, a parallel hook-up will give 25 mfd. This will replace one condenser—a slight saving.

The filament circuit (see Figs. 3 & 4) needs little changing. The series-connected tubes all take .3 amps. The 85, 6A7 and 78 each drop 6.3 volts, [see page 39]

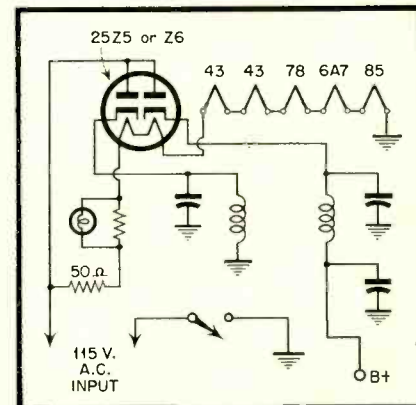
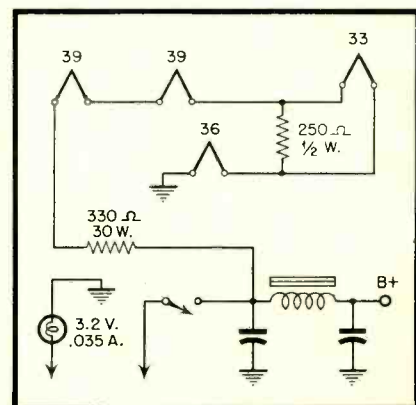
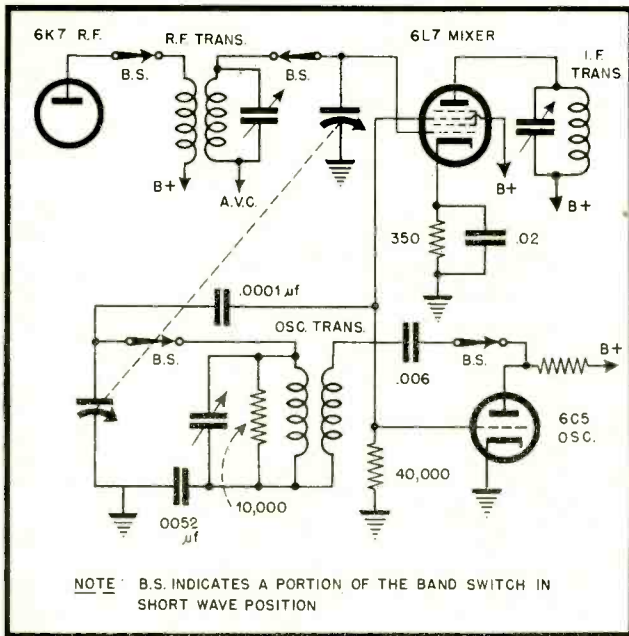

Figure 4. Revised power supply and filament circuit, Atwater Kent 206D.

Figure 5. Filament circuit, Emerson L-DC-4. Rewire to operate AC-DC by removing 250-ohm resistor, substitution of 6.3-volt, .25A light, 25-ohm shunt, for the 3.2-volt, .035 amp. lamp present.





## PART 2.

Figure 8. Simplified schematic, Crosley Model 1155. Application of 6L7 mixer and 6C5 oscillator.

It has been observed that with tubes designed for low frequency operation, frequency *shift* occurs with variations of terminal voltage when the tube is operated at high radio frequencies. This effect is particularly noticeable with A.V.C. variations. One of the features of this circuit is that A.V.C. and terminal voltage variations have negligible effect on the oscillator frequency because the oscillator tube is removed from the influence of the mixer. While the 6L7 is satisfactory for frequencies up to 20 or 30 megacycles, at higher frequencies, transit time effects within the tube result in unsatisfactory operation.

### 2. Triode Heptode Converter (6J8 type)

The triode heptode converter contains a triode section used as an oscillator, and a heptode mixer. The triode

# CONVERTER, MIXER & OSCILLATOR

by S. L. MARSHALL

## Discussion and Classification of Circuits Used to Date

### CLASSIFICATION

With slight modifications converters and mixers can be classified in five general categories. These are as follows:

#### 1. Pentagrid Mixer (6L7 type)

A circuit illustrating the application of the pentagrid mixer and a separate oscillator is shown in Fig. 8. The

6C5 is connected as a modified Hartley Oscillator, and its energy is fed into one of the 6L7 grids. The effect is to influence the electron stream which is already being influenced by the grid which is connected to the R.F. section. As a result beat frequencies are produced in the plate circuit, where the I.F. transformer passes on the desired signal and short-circuits all others.

grid is connected internally to one of the heptode grids. This can be readily seen in Fig. 9, which shows an application of this tube in a three band short-wave receiver. The oscillator circuit shown is a modified Hartley, the output of which is fed into the heptode electron stream by means of the grid mentioned above. The 6J8 is very similar to the 6L7 as far as the mixer section is concerned. However, the 6J8 shows frequency stability of greater superiority where terminal voltage variations occur.

Figure 10. Simplified schematic, RCA Model 85T. Application of 6A8 pentagrid converter.

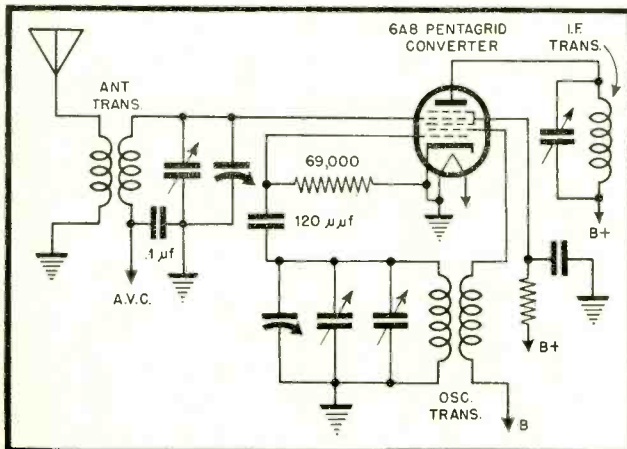
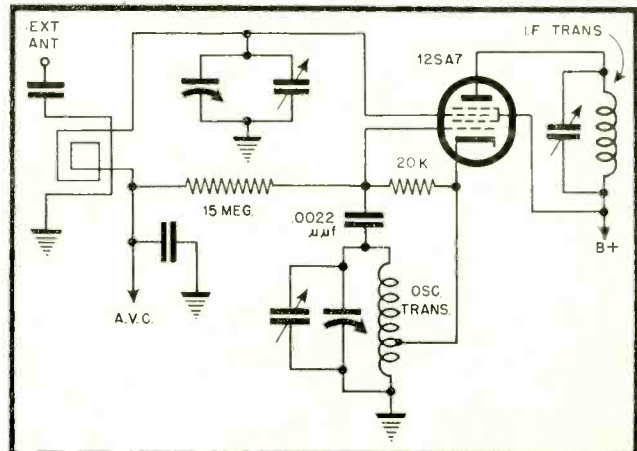

Figure 12. Emerson Model DB-301. Application of 12SA7 pentagrid converter.





### 3. Pentagrid Converter (6A8 type)

One of the most popular tubes in the middle and late 1930's was the pentagrid converter of the 6A7 or 6A8 types. A typical circuit employing this type of tube is shown in Fig. 10. The first two grids serve as the control grid and plate, respectively, of the oscillator section. The remaining grids and plate make up the tetrode mixer. Up to 20 megacycles or so the tube operates fairly satisfactorily. Above this range undesirable effects, such as frequency shift due to terminal voltage variations and capacity coupling between electrodes make this type of tube unsatisfactory for short wave reception.

### 4. Triode Hexode Converter (6K8 type)

The triode hexode converter consists of a separate triode oscillator unit and a hexode mixer. Due to its construction, frequency shift is kept at a minimum. In addition, the low inter-electrode capacitance of the tube makes it

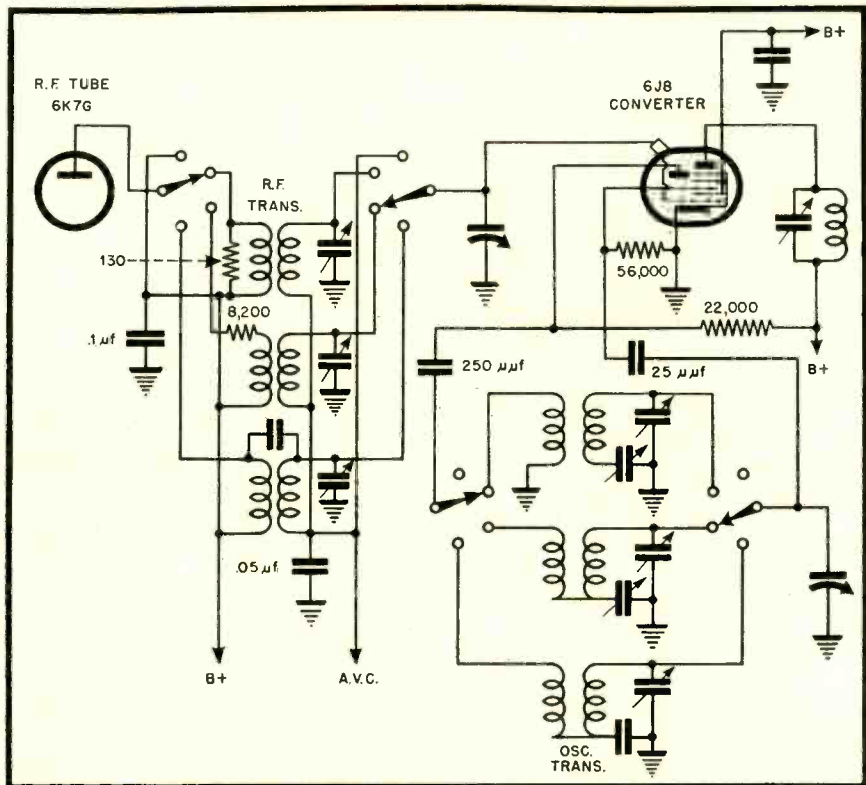

# CIRCUIT APPLICATIONS

particularly suitable for high frequency operation. A typical circuit arrangement is shown in Fig. 11. The oscillator consists of a plate-tuned feedback circuit with a compensating resistor and capacitor network included to correct for frequency drift. The output energy is coupled into the mixer circuit by means of the internal connection between the triode and mixer grids.

### 5. Pentagrid Converter (12SA7 type)

The 12SA7 type of pentagrid converter is a popular type of tube because of many reasons. First, its gain is very high. Second, its frequency stability with terminal and A.V.C. voltage changes is good. Third, it makes possible the use of a single, tapped coil in a Hartley or Electron-coupled circuit which gives excellent results. Finally, it is a single ended tube, permitting of under chassis wiring to all connections. A typical circuit arrangement is shown in Fig. 12.

#### Comments

Occasionally, it will be observed that a gimmick, or capacity turn is connected between the control grid of a mixer unit of a converter and the oscillator grid. Such arrangements

might often be found in receivers using a 6A8. The purpose of this device is to neutralize the effect of a space

charge in the vicinity of the control grid causing a reduction in tube gain. Removing this connection most often

Figure 9. (Above). Simplified schematic, Sparton Models 640LX, 740LX. Application of 6J8 triode heptode converter. Figure 11. Simplified schematic, GE Models HM80, HM85. Application of a converter circuit in a frequency modulation receiver.

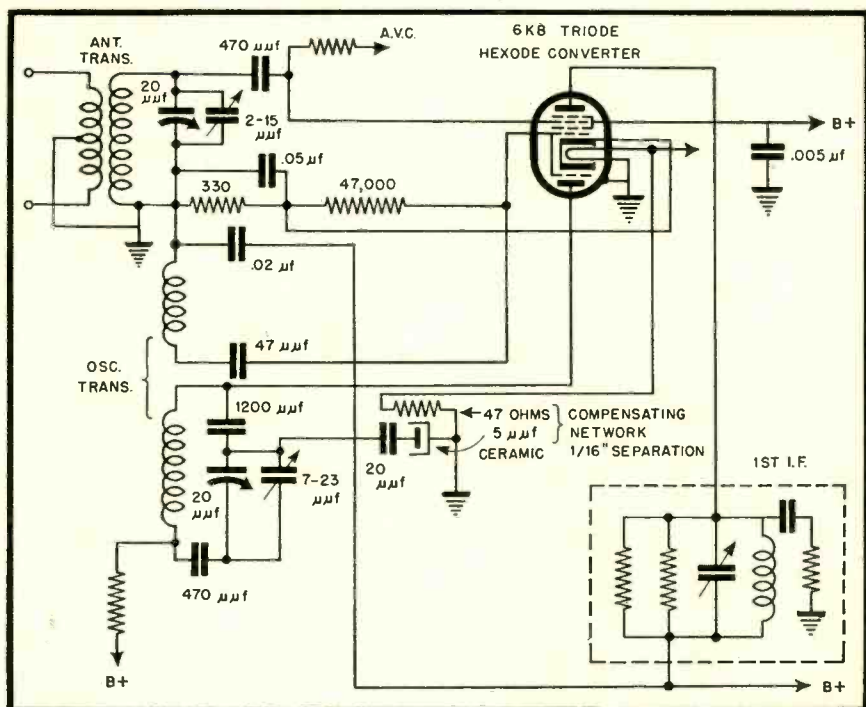

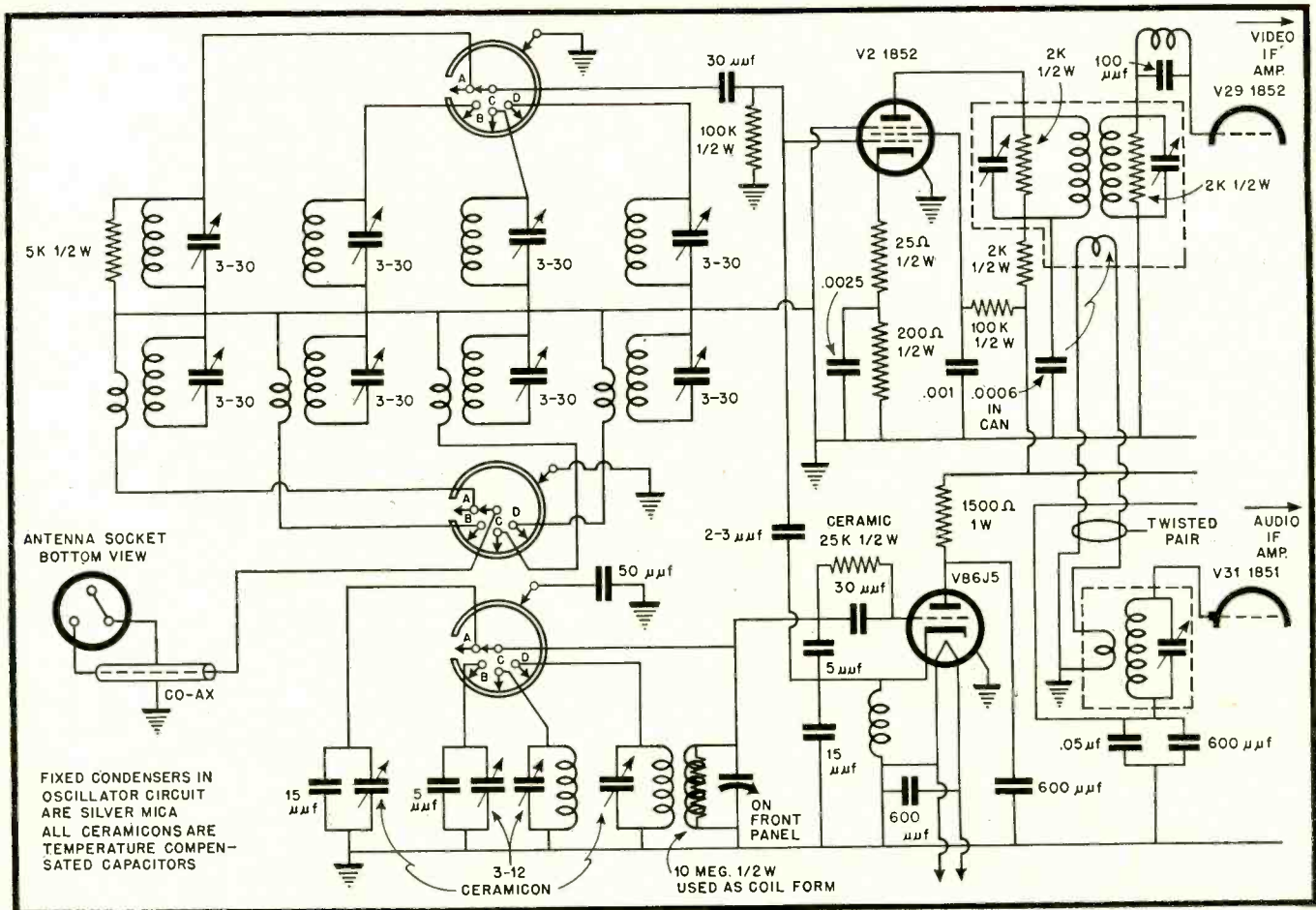
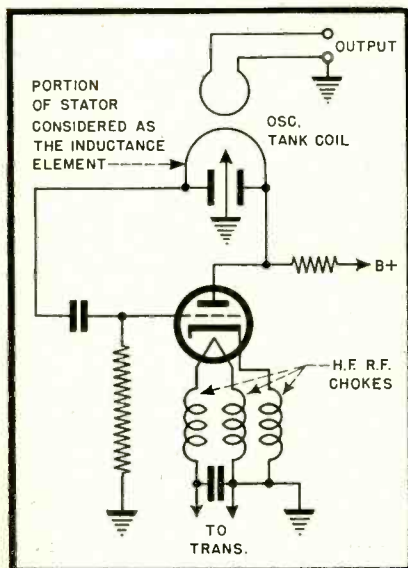

Figure 13. Dumond Model 180-TD30 television receiver. Conventional 6C5 capacitive feedback, grid tuned oscillator; output of this is injected into suppressor grid of the 1852 mixer.

results in poor high frequency reception.

As the frequency of reception is increased, the tendency to frequency shift is likewise increased. A sharply tuned I.F. transformer cannot be used where this shift is considerable. For this reason high frequency receivers use broad band I.F. transformers.

Figure 14. Application of U.H.F. Colpitts oscillator circuit.



Due to variation of frequency with terminal voltage exhibited by converters at the higher frequencies, it will be generally found that A.V.C. on the control grids of these tubes is omitted in favor of fixed bias.

### F. M. AND TELEVISION CONVERTERS

Frequency drift is particularly experienced at the higher frequencies employed in F.M. and television receivers. This is due to rather complex actions caused by thermal and other effects within the tube, and in the materials making up the component parts around the tube circuit. Poor insulator material, and inferior condenser dielectrics contribute considerably to this effect. Much of this effect may be balanced out by using ceramic capacitors with negative coefficients of expansion, or by the use of compensating networks such as the one illustrated in Fig. 11.

The new F.M. and television channels are somewhat below and well above 100 megacycles. It is obvious that at these frequencies the oscillator, mixer, and converter circuits must be designed with considerable care if stable and efficient reception is to be expected. Receivers employing both a

separate oscillator and mixer, or a single converter are used in F.M. and television reception, although it is generally agreed that the former combination gives better results.

The types of oscillators employed do not vary basically from the types previously discussed. For instance, in Fig. 13, which illustrates the circuit diagram of a typical television receiver, the oscillator circuit used is a conventional 6C5 capacitive feedback, grid tuned oscillator, the output of which is injected into the suppressor grid of the 1852 mixer.

Because of their excellent high frequency characteristics, Acorn tubes are fast becoming the most popular type of tube for use in u.h.f. receivers. Another type of tube which has rendered good service in the 40 to 80 megacycle channel is the 1852, and its remote cut-off prototype, the 1853.

The time taken for an electron to travel from one electrode within a tube to another is referred to as its *transit time*. At low frequencies the electron reaches its destination in much quicker time than it takes for the polarity of the cycle to change. At extremely high frequencies, however, the polarity of the cycle might change before the

[see page 40]

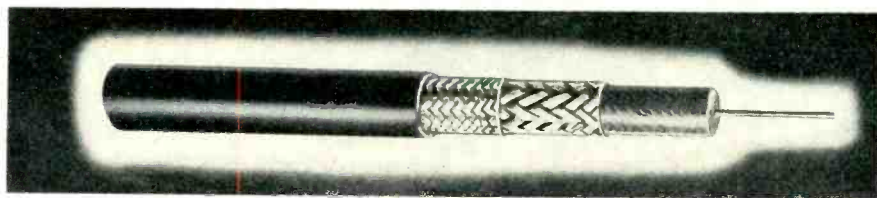

# Television and F-M Lead-in Lines

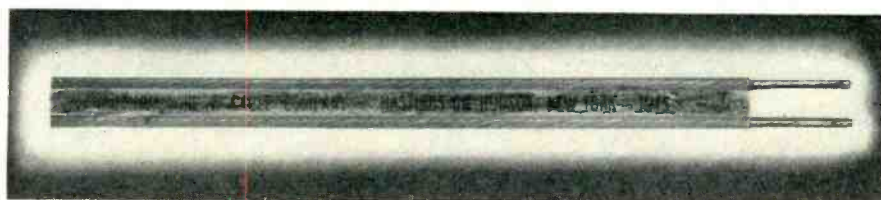

UHF Coaxial Cable (top). Below, ATV Lead-in.

by **DR. E. W. GREENFIELD**

Head, Electrical Laboratory  
Anaconda Wire & Cable Co.

**C**RAMMED into that hectic period, 1940-1945, went what is perhaps the greatest sustained effort in research, development and production of the radio art in history. Almost all of the war-time's amazing high frequency developments have very practical peace-time uses. Uses which will make sea, land and air transportation safer, faster and perhaps more economical; communications more rapid, dependable and economical; and speed the day of universal enjoyment of television in city, hamlet and farm. Let us single out just a few practically realized developments.

## RADAR IN PEACE

(a) The *Loran System* of radio navigation (so named from Long Range Navigation), representing a war-time investment of over 100 million dollars, will probably be standardized internationally as a primary aid to transoceanic plane and ship navigation. By means of three fixed shore installations, a ship or plane receiving electrical pulses in strict time relation, can determine its position from specially-prepared Loran hyperbolic charts to better than 15 miles in 1500 miles. Range of useful application is 750 miles in daylight and 500 miles at night with ground wave, but this can be extended to 1500 miles using sky

waves. Carrier frequency for the pulses is in the neighborhood of 2 megacycles.

(b) *Direction Finder* (D.F.) equipment has found wide use on land, sea and air as a primary navigation instrument. These electrical goniometers pick up high frequency radio waves and indicate their compass course instantly and accurately. Such readings taken from two sources fix the bearings at once. Perhaps the most dramatic use of D.F. equipment during the war was in locating and guiding-in lost planes. Two ground D.F. stations taking a reading on the transmission from the lost plane could fix its location and then "talk" it to safety.

(c) Early warning and search type radars with ranges up to 140 miles and operating up to 3000 megacycles will be used in both mobile and fixed installation as harbor guides, reef warnings, obstacle indicators and the like. One of the most highly engineered electronic devices known, this equipment will make all-weather and night travel safe and practical since the navigator will at all times have spread before him an actual picture of what lies ahead.

(d) Ground controlled approach (G.C.A.) apparatus developed by the U. S. Army has been used for landing planes during weather conditions nearing zero visibility. By means of this equipment, which is a combination of two types of radars, closed-in airports will become a thing of the past and arrivals and departures can be scheduled with no regard to the weather. A

search type radar unit locates the incoming plane on a plan-position indicator. A precision radar on a separate antennae system is then used to provide exact and continuous information of the plane's azimuth headings, altitude and range. This information is transmitted by radiophone to the incoming pilot and he is thus "talked" into the field to a point where visual landing becomes possible.

In all of the above and many other uses not mentioned, the *heart* of the equipment is without doubt the variety of vacuum tubes which generate the ultra-high frequencies, pulse them, modulate them, rectify them, amplify them and finally display them in calibrated degree. In like simile, the *nerves* of the apparatus are the many flexible coaxial and shielded twin cables and wave guides which transmit the energy from component to component, thus welding the units and antennae together to form an integrated structure.

Since these cables must carry energy at the highest frequency used, their construction must be the result of careful design and manufacture and their materials must be of the best known to the art. The early use of ultra high frequency equipment in the war was in a large part impeded by the lack of a suitable cable insulating material. However, the discovery and successful mass-scale manufacture of polyethylene for high frequency insulation (one of the outstanding contributions of war-time chemical engineering) provided just the needed material.

Practically all flexible cable used in radar has been insulated with polyethylene manufactured to rigid specifications. This material completely meets all physical and chemical requirements and at the same time exhibits almost the lowest dielectric losses at high frequency of any known insulating material.

## INSTALLING TELEVISION AND F.M. LEAD-IN LINES

Television and F.M. lead-in lines are used to transmit energy received by the antenna to the receiver. Since, in the proper reception of television signals, it is required that the antenna be placed in such a position as to have relatively unobstructed air line from transmitting station to receiving station, the antenna must, in general, be placed at an elevation above the roof of the receiving location. This means that for most cases an antenna-to-receiver distance of from 50 to 100 feet is usual for the average home whereas for apartment houses and hotels, depending upon surrounding buildings, the lead-in cable may be as long as

[see page 42]

# Flexible FINANCING PLANS

**New features of finance plans ease dealer's risk on customer sales, help dealers on buying for stock. CCC plan described. First of a series of articles on sources of consumer money.**

by **LEWIS C. STONE**  
Editor

**D**EALERS are preparing to get their share of the radio and home appliance business in the approaching (though as yet remote) days of full and unrestrained production. Before they can sell, they must buy. And in order to buy enough goods to make it worth while to stay in business, dealers will themselves need financing. During the war years, finance and credit companies have been marking time. Now, they are becoming active again, outlining rather comprehensive programs and plans which will take care of the dealer's buying requirements as well as his selling capacities.

Among firms who are making their post-war bid for financing the wholesale purchase of appliances for dealers and, in turn, the retail sales by dealers to consumers—is the Commercial Credit Company. In a general announcement to the trade issued by Howard L. Wynegar, president, he states:

"The tremendous pent-up consumer demand for household appliances presents an unprecedented market—an opportunity to create potential sales volume and an opportunity to realize a substantial profit. However, it can logically be expected that this fertile field will intensify the efforts of estab-

lished dealers and it will also attract many new dealers into the field—hence, the market will be highly competitive.

"In some quarters there is the belief that accumulated war-time savings will automatically flow into retail channels for the purchase of vast quantities of consumer goods—that the percentage of cash buyers will be abnormally high. The mass market—the families with annual incomes of \$3000 or less—represents the major portion of the total market and these families hold a relatively small percentage of all war-time savings. It can reasonably be expected that many of these families will retain their savings and that the large majority will, as in the past, purchase out of income on the monthly payment basis. Financing, therefore, will be a highly important part of the dealer's sales program.

To meet this situation—as and when radios and appliances *do* get produced, *do* get to distributors, *do* get displayed in retail stores and *can* be bought by commodity-starved customers (and last, but not least, *can be delivered to those customers*)—finance plans have been arranged which have many new features, as this article will show.

In connection with time payment sales to the consumer, some five plans have been worked out. What the CCC calls its 5 Star Finance Plan, for example, includes:

1. Purchaser Life Insurance. This new feature includes Creditor Group Life Insurance on the lives of time payment buyers. It provides that in case of death of the purchaser during the term of his obligation his debt, excluding amounts 60 days past due, is cancelled. The customer's family or estate is given a clear title to the merchandise.

2. Dealer Reserve Plan. Provides a credit loss reserve for the dealer of 10 per cent of the full financing charge. Also in addition to life insurance the customer receives property insurance on the appliance bought. The credit loss reserve feature can best be appreciated by the dealers who have been in business for some years and who recall the effect on their profits of "depressions", "recessions" and local catastrophic situations which have affected the ability of certain numbers of their customers to pay their instalment obligations.



**COVER PHOTO**

Close-up of "Radio-Appliance Time Table" shows how dealer Emmons Moser (Long Island) "tells all" to his customers. Two columns at left, headed "immediate", list various traffic appliances, small radios, record players and a popular make of console combinations. Middle column, headed "two weeks" lists major appliances with miscellaneous small items. Fourth column, headed "one month", shows more heavy appliances, plus automatic toasters, etc. Column at right, headed "indefinite" lists disposal units, 2-door refrigerators, television sets, automatic washing machines. See cover for full view of this display.

3. Non Recourse. This is an entirely new plan. It relieves the dealer of all financial liability. Naturally, the dealer must make the usual warranties, and agree also to maintain service, and to repossess in case of default. There is, of course, no dealer reserve, but the property and life insurance features for customer benefit are included.

4. Limited Liability. Such plans are not new, but offers added features. There is no waiting period, as in other similar plans. Charges have been reduced below any previously offered on a nation-wide basis for limited liability service. Insurance covering the life of the purchaser and the property is included.

5. Dealer Guarantee. Designed to provide a very low finance charge. It does not carry insurance for the purchaser and requires the full guarantee of the dealer without a reserve or limit of loss protection. Where a low rate is the primary consideration to a dealer this plan is streamlined to permit it.

#### Financing for the Dealer

Wholesale Plan. Financing of floor displays enables dealers to compete successfully with floor displays of de-

partment stores, chain stores and public utilities. The dealer must put up a minimum deposit of 10 per cent, plus a flat charge. The maximum advance by CCC is 90 per cent, less flat charge. Term is 90 days maximum; flat charge is 1 per cent of the amount advanced, \$1 being the minimum. The monthly charge is 3 per cent per annum, based on the average daily balance of accounts outstanding during the month. Dealer is billed for the earned charges only. Here is how it works: (Example).

Dealer purchases appliances at wholesale amounting to.....	\$1,500.00
Dealer's down payment (at least 10%) .....	150.00
Balance to be financed is.....	\$1,350.00
This amount is to be financed for 90 days.	
Flat finance charge is 1% of \$1,350 or .....	13.50
Total amount dealer owes .....	\$1,363.50

In addition to the down payment of \$150.00 dealer pays distributor or factory the wholesale flat charge of \$13.50, making the total check to him \$163.50. The distributor or factory sends the paper to the CCC office and receives a check for \$1,336.50.

Three renewals for 30 days each

are allowed, upon approval, providing the dealer curtails the principal amount by 10 per cent each time and pays an additional flat charge of 1/2% of the reduced amount extended.

If monthly carrying charges are paid in advance for a specified period, such charges will be adjusted against the average daily balance charge and any remaining credit to be returned.

The finance charge includes fire, theft and transportation insurance. This insurance covers the dealer's interest for the full wholesale invoice price of the appliance financed under the wholesale plan. It is effective from the time you receive the merchandise to the date of sale, or payment of note and transfer to the dealer of title to the appliances ordered.

Dealers who carry a blanket policy covering their stocks or merchandise should be sure to exclude the appliances financed under the wholesale plan from such a policy. This avoids duplication of insurance, and the possibility of legal complication in the event of loss.

Merchandising angles go with the finance plans and arrangements outlined above. Collecting is helped along by courteous reminders by [see page 30]

## ZENITH SET SHOWING ATTRACTS CROWDS

Thousands of persons crashed the opening of Zenith's first public showing of its new line in the Commonwealth Edison building here recently, jeopardizing the brand new sets so seriously that hurried calls for help had to be made.

More than 15,000 were clocked through the exhibit in the first half day, with everyone pushing for a chance to twist the dial of a new Zenith. Hastily erected ropes kept the crowds back on following days, but the people kept coming to see and hear the latest in radio. More than a quarter of a million persons saw the display within the first week.

The people jam-packed themselves around the radio-record player combi-

nation, with its Radionic Cobra Tone Arm, introduced in current advertising as Zenith's sensational new way to play records. They were there to hear for themselves the new quality possible in record reproduction and they saw the tone arm dropped on a revolving record without damage to the tone arm, the record player, or the record.

The crowds confirmed the wartime market surveys which showed people interested first in obtaining radio-record player combinations. From the combinations on display, people moved immediately to the new Zenith portables.

Writes Ted Leitzell, of Zenith: "... I am enclosing two pictures of



Jack Riley and Owen Mangle, Zenith Radio Distributing Corp. men, in process of demonstrating sets and controlling mammoth crowd at show.

the 'mob' scene. Unfortunately, this public display of interest caught us unaware so by the time we got a photographer there, the scene was fairly orderly. But (this picture) shows the way they were stacked up four deep . . ."

#### SETS THEY WILL BUY

Inquiries at the showing revealed that people wanted the record player combination as the main unit in their homes, and a portable as a second radio for use throughout the house.

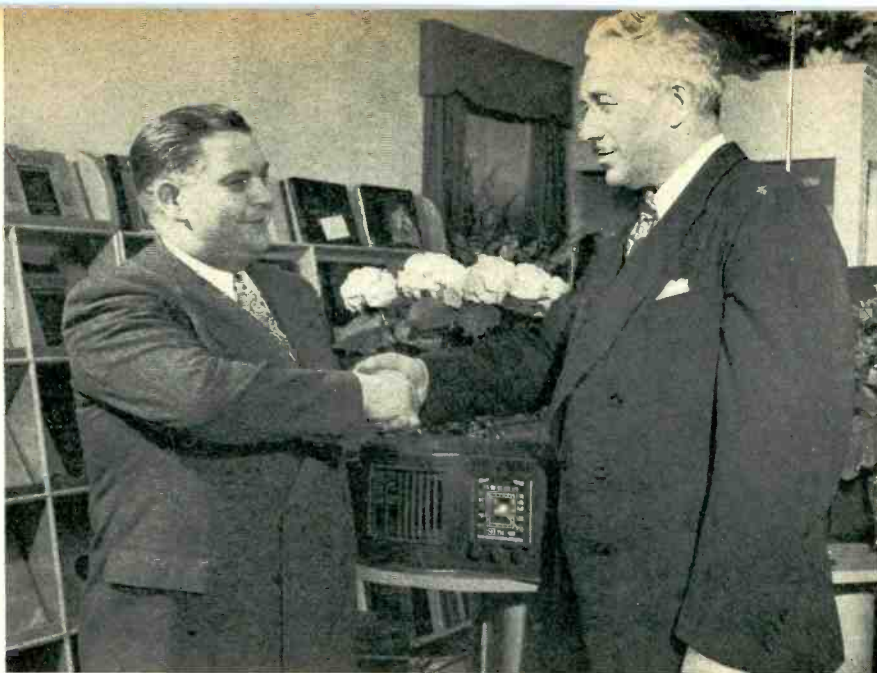

## Veteran & Champion OPENS RADIO & APPLIANCE STORE

**Dealer Ross is War I & II vet., ex Olympic champ. Long in show-biz end of radio, on 400 Hour program. New store is deluxe equipped for radio, record and appliance business, including servicing.**



*Top:* Dealer Ross (right) is greeted by Russ Jimieson, vice president, Walker-Jimieson, Inc., Sonora distributors, at gala opening of Norman Ross & Co. radio, record and appliance store in Evanston, Ill.

*Left:* Modernized double show windows offer ample display space for merchandise and selling promotions. Store's 6,250 square feet will house complete lines of radios, records and household electrical appliances.

*Bottom:* Servicing is now the bread under the butter of business volume. Russel Hunt, at work on portable record player, is former NBC studio engineer, 20th Air Force veteran.

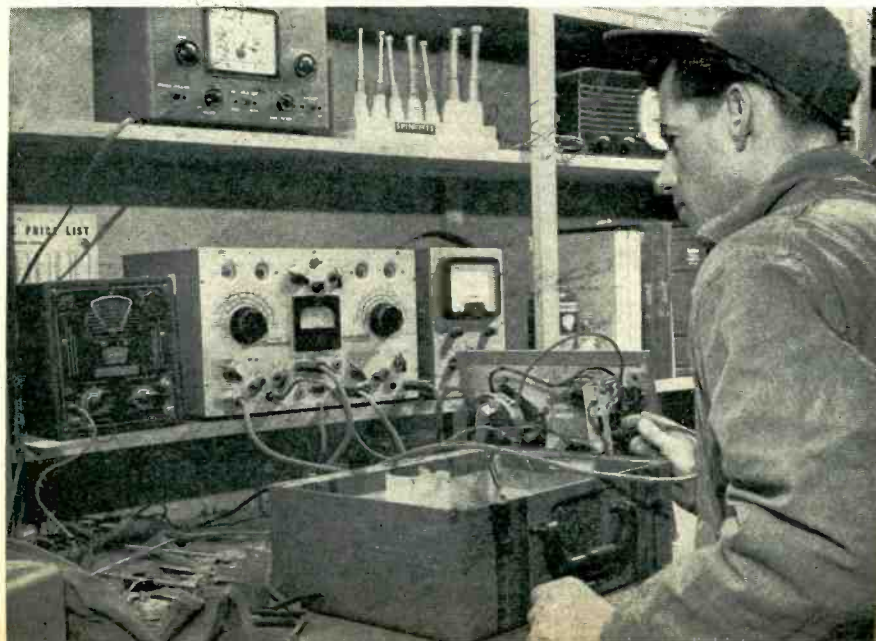

**N**ORMAN ROSS, radio commentator, master of ceremonies, Olympic swimming champion, and distinguished World War I and World War II ace, officially opened his new radio and electrical appliance store on April 4, 1946. The store is located at 617 Davis Street, Evanston, Ill.

The new establishment is a "double" store and occupies approximately 6250 sq. ft. of floor space, devoted to display of radios, phonograph records, and electrical appliances, featuring all that is new and modern in the electronic and electrical fields. The dealer handles Sonora, Zenith, RCA, G-E, Bendix, Stromberg-Carlson, and Motorola franchises.

The radio service department is headed by Russell Hunt. Hunt was three years and eight months in service with 20th Air Force. He was stationed in Guam and is a former NBC studio engineer.

The radio service department is equipped to handle repairs and replacement parts on radios, phonographs, and record players. Radio and sound engineers of Walker-Jimieson, Inc., distributors of radio and electronic supplies, aided Norman Ross & Co. in setting up service department facilities.

Interior decorations, displays, and modernistic window settings were conceived and executed by Barnitz Studios, Evanston, Illinois.

### "Built-In" Merchandising Features

A "downbeat room" is located in the basement where the younger set will have complete freedom to play and hear popular recordings. Built along the lines of a playroom, it will help neighborhood jitterbugs to find

after-school recreation and amusement. "Downbeat room" features a coke bar and a juke box. Also large drawing boards are placed along the walls for cartooning efforts of the guests. Recognizing the possibility of youngsters' desires to whittle, panels have been placed on the walls and whittling knives furnished for the carving of initials by the jitterbugs. Walls are panelled in knotty pine. In charge of the "downbeat room" is Miss Ethel MacVeagh.

Assisting Mr. Ross in the direction of the venture is Pasquale (Pat) Gallicchio, who filled Norman Ross' shoes during the two and a half years Colonel Ross was in the Army. Gallicchio took over the broadcasting of the 400 Hour Show and established an all time mark record for local radio shows when he received more than 35,000 letters in one week indicating that listeners prefer classical recordings.

A main floor record department is in charge of Velma (Dinty) Moore, who has sold records from Canada to Hollywood during her many years of experience. Before joining the Ross organization, Miss Moore headed the phonograph record department of Carson Pirie Scott Company for five years.

### What Makes a Dealer?

Mr. Ross is a man of varied experience, all of which adds up to a well-rounded personality. As these photographs show, the new store is the product of an unusual personality. He enlisted in the air corps in World War I, won his wings in the class with Jimmie Doolittle in 1918. Remained with the occupational army and represented the U. S. in the Inter-Allied games held in Belgium, winning all the swimming events for the Yanks. Member of the 1920 Olympic swimming team and won both the 400 and 1500 meter events—the only American ever to win both honors.

In World War II he was a captain, assigned to headquarters, AEF office of flying safety. Wrote the Air Force "Accident Investigation and Analysis" manual. Assigned a B-25 but piloted everything from an AT-6 to a B-29; went overseas in 1945 as an aide to Doolittle.

In 1931, he entered radio as an announcer, and in September 1935 he began what is now the 400 Hour program, known then as the Illinois Central Suburban hour. For the past 12 years Mr. Ross has had only sleepy engineers, a microphone and a few insomniacs for a studio audience. Now, he says he wants to "meet many of the people I have talked to for such a long time". He feels that this store will give him that chance.



"Stream-flow" sales counters attract shoppers; eye-level displays increase record visibility, simplify shelf-selection of wanted discs by ample force of selling personnel. (L. to r.): Velma "Dinty" Moore, Betty Jean Ross, Ethel MacVeagh, Norman Ross (the boss), "Patsy" Gallicchio, Joycelynn Clausen, Mary Amidon.



Above and below: Merchandising feature is "Downbeat Room", basement headquarters for teenagers, spot for afternoon dates and dances. Complete with soundproof recording booths, juke box, "coke" bar. Record displays share walls with drawing boards and whittling panels, much used by teenagers.



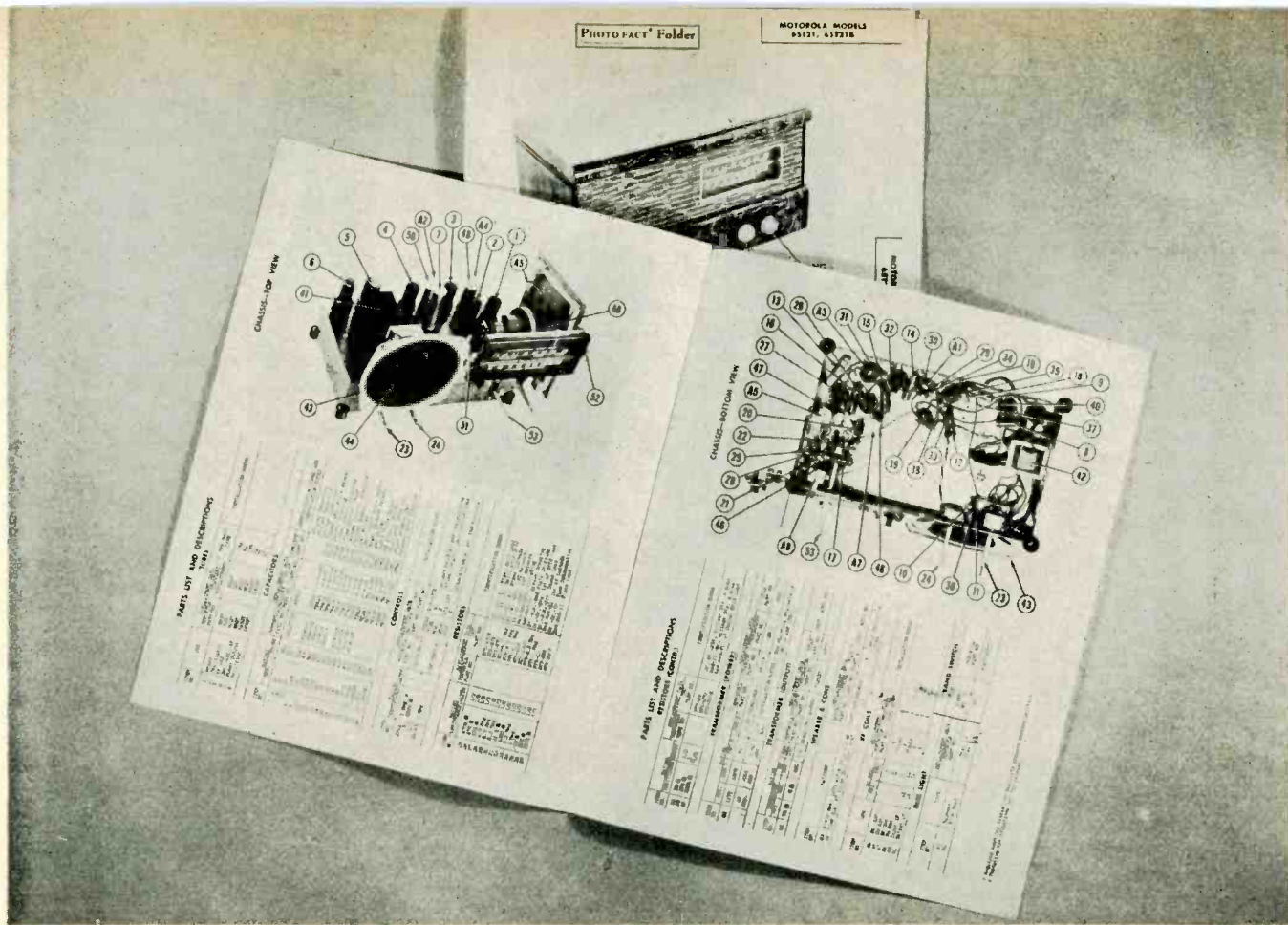

## New Servicing Data Plan

**I**NAUGURATION of a revolutionary method of supplying the entire radio field, from set manufacturers to radio service engineers, with servicing data on the thousands of new receivers to be built for the post-war market is announced by Howard W. Sams. The new organization, Howard W. Sams & Co., Inc., 2924 E. Washington St., Indianapolis, Ind., will begin distribution of the radically different Howard W. Sams Radio Encyclopedia Service on June 15th.

Creation of the service, according to Mr. Sams, was prompted first by the inadequacy of the old servicing data material which supplies only a schematic diagram of the receiver chassis and sketchy data on the various parts of the set, and, second, by the tremendous increase both in number of receiver manufacturers and variety of models to be produced in the days ahead. In the past, the radio service engineer needed information only on the products of 36 receiver manufacturers, whereas today there are 212 manufacturers (radio and phonograph combined) who will produce more than 1,000 models among them.

The Radio Service Encyclopedia will be issued periodically in the form of "PhotoFact" Folders, each folder covering one receiver model. The folders will vary in size from 4 pages to 12 pages, depending upon the compli-

cations involved in the receiver, and will be profusely illustrated and contain completely identified lists of parts and suitable replacements as well as detailed engineering data and voltage and resistance analysis.

These folders will be sent to users of the service in folios of 30 to 50 at frequent intervals and as rapidly as new receivers are placed on the market. The complete service folder on a new receiver will be delivered to subscribers within 90 days after the set

goes on sale. The organization has secured the close cooperation of the receiver manufacturers in order to insure having the service folders on their sets in the hands of service engineers at the expiration of the RMA 90-day guarantee period. The cost of a complete folio of 30 to 50 service folders will be \$1.50 to the radio service engineer.

A sample of every new receiver will be secured immediately after it goes into production and its engineers will analyze each set, check and list every component part, record each resistance and voltage value and test the set in every particular as a preliminary to

[see page 46]

### DETAILS OF SERVICE FOLDERS

The following detailed description of the Sams "PhotoFact" Folders shows the completeness of detail involved and demonstrates why their use will free the service engineer from working with cumbersome and complicated cross-indexes and manuals:

1—There will be a "PhotoFact" Folder covering each individual receiver placed on the market after January 1, 1946. Folders will contain from four to twelve pages of photographs and service data.

2—Each folder will contain from two to twelve photographs of the chassis taken from various angles so that every component is clearly recognizable and identified for reference to the accompanying list of parts.

3—A keyed reference Parts List will give complete specifications for each component, the manufacturer's part number, available replacement type or types and other installation notes.

4—There will be a keyed reference alignment procedure for each set with adjustment frequencies and recommended standard connections.

5—Complete voltage and resistance analysis will be given for each receiver. This will include actual measurement data for voltage and resistance at each socket prong to record actual new set performance.

6—Complete stage gain measurement data.

7—A schematic diagram.



# CIRCUIT COURT

## INPUT CIRCUITS

Fig. 1 represents a simple, and frequently encountered input circuit for a table model receiver designed primarily for loop operation, but with provision for an external antenna where a need for greater pick-up is found. The components include the loop, which may be either helical (turns of differing diameter) or solenoid (turns of same diameter); a smaller loop coil to provide coupling from the external antenna if one is used; the tuning capacitor and its associated trimmer condenser; capacitors providing return to common ground for both the loop or grid circuit and the external antenna.

The tube whose grid is shown may be either an RF amplifier or the mixer stage. It is standard practice to apply AVC voltage to this stage so the capacitor C2 is incorporated to provide an RF path to ground for the loop circuit. This capacitor may vary from .01 to .05 mfd., the latter value being quite common. The tuning condenser, market TC, will be one of the gang which provides frequency selection, and will tune the loop to the frequency of the station being received. The trimmer is provided to permit re-sonating the loop-TC combination at the high frequency end of the band.

The chassis ground may, or may not, be common to one side of the lighting circuit in the case of an AC-DC receiver so C1 is inserted to prevent a short circuit from resulting if a ground lead or grounded antenna is connected to the external antenna lead or terminal. Typical receivers employing this circuit are the Bendix 526 series and the RCA 55U chassis.

When an external antenna is used the signal, and noise, picked up by it is added to that picked up directly by the loop. Unless signals are weak or distant reception is desired it is usually advisable to leave off the external antenna. In an area of strong signals, broadcast or other-

wise, it is possible to run into more than a little trouble with birdies, harmonics, beats and across modulation. If the set has an RF stage this may not be so bad but reception will still suffer interferences on certain channels. The advent of pulsed signals in many sea-coast areas may tend to shock excite the first stage at frequencies widely differently from the one to which the receiver is tuned.

Many variations of the simple circuit shown in Fig. 1 are in common use but most of the theory still holds. In Fig. 2 we find several minor changes. In the first place, no capacitor is provided in the external pick-up circuit. The loop is found returned to chassis ground, as are the tuning condenser and trimmer. In order to provide AVC voltage on the first tube grid it is now necessary to isolate the grid from the loop by C3, which might be in the order of .001 mfd., and return the grid to the AVC bus through the resistor, R2. These features are all to be found in current production receivers, mostly in those few AC instruments being offered.

Additional variations possible on the basic circuit are shown in abbreviated form in Fig. 3. "A" shows the isolating capacitor in the antenna circuit instead of the ground. Electrically there is no difference. Clarion model 100 is typical of this, and the value may be from .001 to .01 mfd. in either location. 3B has the capacitor in the antenna lead and a resistor, in this case of 1000 ohms, between it and the coil. This resistor, marked R1, will flatten out the response in case the antenna and coupling coil resonate in the broadcast band. Airline model 54BR series uses this circuit.

Fig. 3C shows two leads from the coupling coil in place of the one previously shown. Here we find that the connection to an external ground, as well as antenna, is contemplated. This is

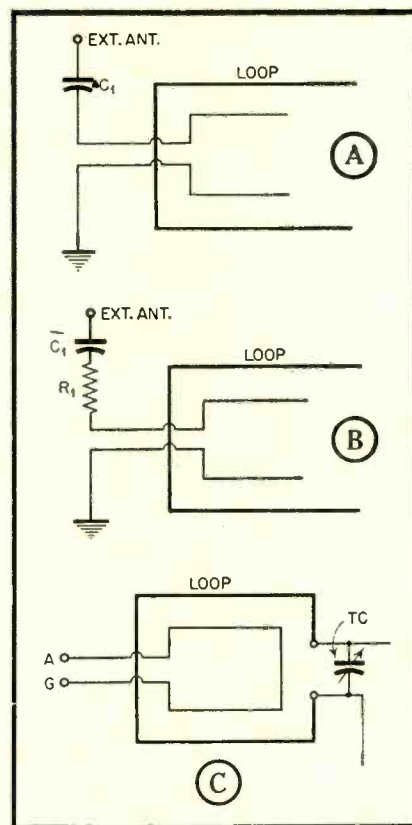

Figure 3 A-B-C

good practice since the ground return in the other cases is via the lighting circuit and subject to feeding to the first tube grid any interference voltages occurring in the light circuit. Provision of a separate, preferably short, ground lead and an antenna well in the clear from adjacent light lines should go far in the attempt to improve signal-to-noise ratios in those spots where signals are weak and noise strong. Airline 64BR, Zenith 6C21 and 22 and Sentinel 284 series use this system.

It will be recalled that shortly before the war some sets appeared on the market without the conventional tuning condenser. In these cases, either one or more of the circuits was tuned by the

Figure 1

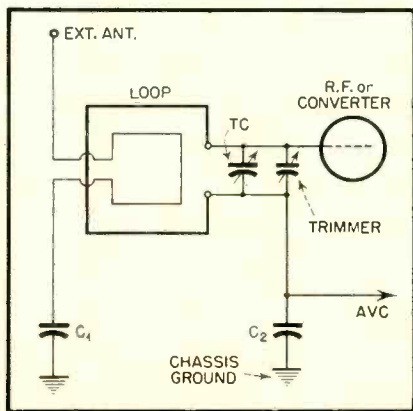

Figure 2

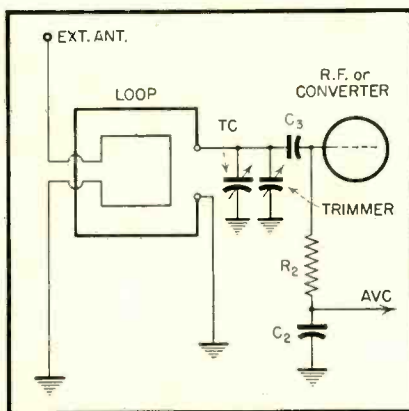
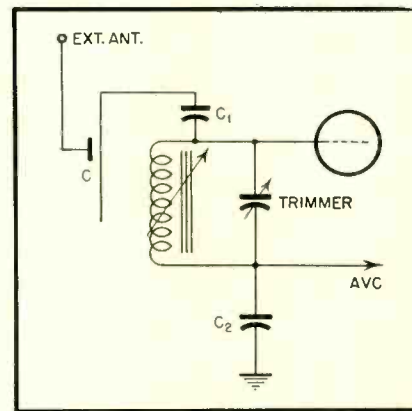

Figure 4



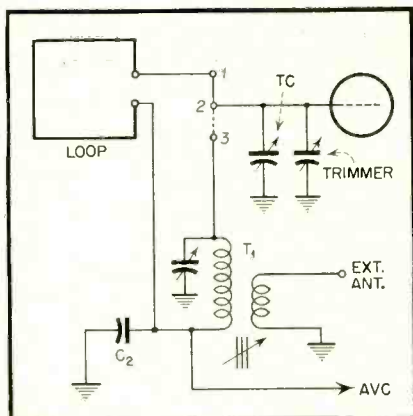

Figure 5

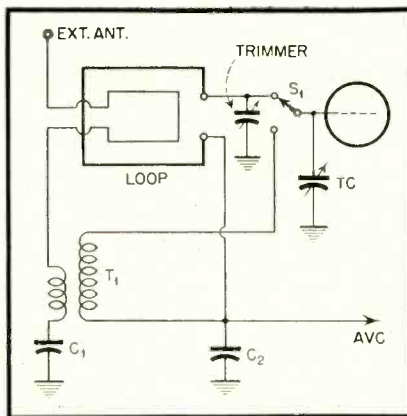

Figure 6

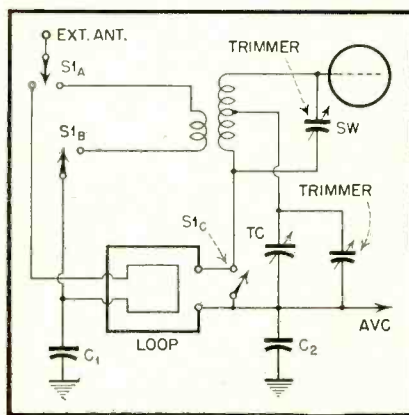

Figure 7

Figure 8

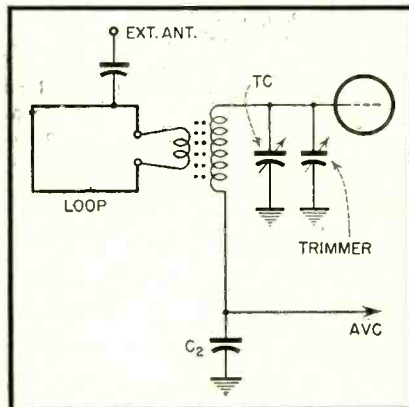
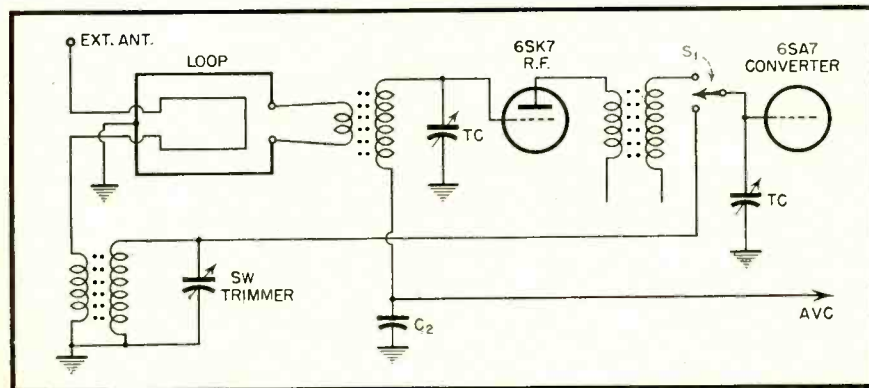

Figure 9



loop or antenna operation on one band. This is the circuit used in the *Clarion C1040*. A link is provided which can connect between adjacent terminals 1 and 2 for loop operation, or between 2 and 3 for use of an antenna. In the latter case transformer T<sub>1</sub>, of the iron core variety, makes possible an excellent match between antenna and grid and provides considerable gain. A separate trimmer is provided for each type of connection.

To return to consideration of the multi-band circuits, let us examine *Fig. 6*. In this set, the *Truetone D2630*, we find the conventional loop and coupling coil for the broadcast band. In series with the antenna coil is the primary of T<sub>1</sub>, the short wave unit. A switch, S<sub>1</sub>, permits connecting the grid of the first tube to the loop or the transformer as bands are shifted. Some short wave pick-up is possible because of the loop being coupled to the high side of the primary, but an antenna should be used for good results. It will be observed that the returns of both loop and secondary are common to the AVC bus and by-pass capacitor. This is typical of several receiver models.

In *Fig. 6* the tuning condenser was connected from grid of the first tube to ground so was used on both bands similarly. This would provide wide frequency coverage for the short wave band, but tuning would be difficult unless considerable mechanical reduction were provided. This provision would make tuning on the broadcast band slow and laborious.

Consideration of *Fig. 7* will demonstrate a method of giving some spread to the high frequency band. This circuit, found in the *RCA 56X10*, works as follows: The secondary of the short wave transformer is connected to the grid and tapped. The tuning condenser, with associated trimmer, is connected from this tap to the AVC bus, and through by-pass C<sub>2</sub>, to chassis. The loop is between the bottom of the secondary and AVC bus. Switch S<sub>1C</sub> will short the loop when turned to the short wave position. At that time only the secondary provides inductance in the grid circuit. The tuning condenser, being tapped down on the coil, provides as much bandsread as desired, in this case just covering the 25 and 31 meter bands.

Another section of S<sub>1</sub>, marked A connects the external antenna lead to the loop coil or transformer primary, and section B opens the return from the transformer primary in the short wave position to provide the best condition for broadcast band performance. It can be seen that if this return were left connected there would be considerable capacity coupled across the grid circuit during broadcast reception.

The *RCA 56x5* uses the same circuit. Note that these sets require a special

[see page 41]

use of a powdered iron core moving into a coil. This type of tuning has re-appeared in the *Truetone D2610* and similar sets *Fig. 4* illustrates the details. The trimmer still is provided, and in most cases mechanical alignment of the sliding core will be needed to bring about initial adjustment. The AVC voltage reached the tube via the variable inductance and the usual capacitor C<sub>2</sub> provides a return path to ground for the signal. In this particular case there is a metal plate coupled to the grid via C<sub>1</sub> to provide pick-up. Additional signal can be obtained by connecting an antenna to the terminal provided. A washer, insulated from the plate, acts as one plate of a capacitor and isolates the circuits for all but RF voltages. The high Q of the tuned circuit makes up in part for the relatively poor pick-up of the plate, as compared to a good loop.

All the circuits considered so far have been those of single-band receivers. If it is desired to add short wave reception to the set several methods are open to the designer. He can tap the broadcast coil for the high frequency band, provide another loop which will tune to the short wave band, or install a transformer and make provision for an external antenna, either for the high band or both bands. The latter plan seems most popular and is doubtless advisable from a performance standpoint.

Before looking at the two-band offerings we might glance at *Fig. 5* which shows an admirable method of achieving

# REPLACE CAPACITORS Faster... Better... at Less Cost



with **SPRAGUE ATOMS**



### NEW CATALOG — JUST OUT!

The finest, most complete and most helpful Sprague catalog ever issued! Contains complete details, dimensions, data, etc. on Sprague Capacitors and \*Koolohm Resistors for every service, amateur and experimental need. \*Trademark Reg. U. S. Pat. Off.

SEE US AT BOOTH 132 — CHICAGO SHOW!

- Use them universally for ALL dry electrolytic replacements.
- A small supply equips you for ANY job — any voltage, capacity or capacity combination.
- Order them by name — be sure of getting genuine, factory-fresh Sprague Atoms — the kind that will not let you down.

**SPRAGUE PRODUCTS COMPANY**  
North Adams, Mass.

JOBGING DISTRIBUTING ORGANIZATION FOR PRODUCTS OF THE SPRAGUE ELECTRIC CO.

Radio of the future, with young lady (of the present) displayed some months ago at the Hallicrafters company preview of new radio equipment as an indication of the long range possibilities of electronics in the home. When finally developed, the "radio of the future" is expected to answer doorbells, take and give messages, provide the means for pre-selection of radio programs, feature standard broadcasts, frequency modulation and television, automatically record and remind householders of birthdays and other special events, and do just about everything but sit up with the baby.

# Living Electronically

by WILLIAM J. HALLIGAN\*

**T**HE electronic age is here, and it could not have arrived at a more propitious time. With the release of building materials for new construction, builders will for the first time in years be able to take full advantage of the tremendous strides taken in the field of electronics during the war. The house of tomorrow, built to take full advantage of these modern wonders, will have an "electronic heart," wherein will be contained a modern radio, an inter-communications system, a record changer, a home recording system, and a television receiver.

The modern radio will have all the required facilities for amateur broad-

casting, standard reception and FM, and will have connections leading to every room in the house, with remote control units within easy reach so that any desired program may be tuned in at any time. The hobby of amateur radio, unfamiliar to the average person until recently, will blossom as never before. Responsible for many startling achievements in communications history, it is a source of entertainment and education without a peer.

Television, too, is making giant strides, and will add an incalculable amount of pleasure to our daily home life. It is difficult to conceive a greater field of entertainment for shut-ins who are physically unable to visit the places pictured on the television screen.

\*President, Hallicrafters Co.



Inter-communications systems will assume the proportions almost of a necessity, with remote control units making it possible to talk from any room or floor to another, or to the garage or workshop.

Automatic record changers, constantly being improved for speed and simplicity of operation and fidelity of tone, will contribute greatly to the ease and comfort of the American home, and doubtless help to increase our appreciation of fine music. Home recordings, at first just a fad, will become more and more popular as the possibilities of this field become apparent. Aside from its value as entertainment, it offers a variety of uses for business purposes. The house of tomorrow will live and breathe with the wonder of sound.

with the publisher . . . . .

[from page 8]

Durr's way of thinking, indicates that radio manufacturers do not want to produce receivers covering the more modern and beneficial FM band. Continuing in this vein, the Commissioner cited that although 834 stations have applied for FM permits, 70% of the applicants being present operators of AM stations, on the whole broadcasters are reluctant to go all-out for FM and discard AM because they are satisfied with present profits.

Discussions with major radio equipment and receiver manufacturers and station operators lead us to believe Mr. Durr is 100% wrong in his interpretation of the situation. Set makers would like nothing better than to be able to produce great quantities of FM models, or any other type for that matter, if they were able to do so at a profit. Now material shortages, labor problems and OPA regulations simply do not allow any production on a profitable basis. Transmitter manufacturers are in no better position. Broadcasters can't get equipment that's not being made. Don't Mr. Durr know

this? Hundreds of transportation firms, avidly trying to buy mobile communications equipment; police and fire departments anxiously awaiting the day when they can order two and three way radio apparatus; steamship lines; airports and airlines, and industrials wanting p. a. systems, all together representing millions of dollars worth of radio buying potential, and all allowing for the profitable employment of thousands of trained technicians and operators,—they are stymied and held back, as is the public from getting FM receivers and programs, not because set makers, transmitter manufacturers or broadcasters want to keep FM from being born, but just because OPA is adamant about keeping prices down to levels where it don't pay to produce.

*S. R. Lowan*  
Publisher

**MEN IN THE NEWS**  
[from page 6]



**Fred Parnell**

pany's Receiver Division, Bridgeport, Conn. The announcement was made by Paul L. Chamberlain, Manager of Sales for the division.

As an account manager at Maxon, Inc., in New York, Mr. Parnell for the past year has supervised the G-E Receiver Division's advertising and sales promotion handled by the agency.

Mr. Parnell entered the agency field in 1941 after more than 12 years in advertising and sales work with General Electric, where he had served as sales manager of the Conduit and Wire Sections, handled promotion for the G-E Home Bureau, and was advertising manager of the Construction Materials Division.



"Bill" Speed, president Audio Devices (left) sees his sales manager C. C. Pell, Jr., off in the new plane.

**To "Cover Ground" by Air**

An airborne service unit, designed to implement a new company program of accelerated customer contact and technical educational service, was commissioned recently at LaGuardia Field today by Clarence C. Pell, Jr., ex-war pilot and national sales manager of Audio Devices, Inc., New York, manufacturers of Audiodiscs, instantaneous recording blanks used for radio program transcriptions and master recordings from which phonograph records are made. [see page 44]



Alfred A. Ghirardi — the man who takes the headaches out of Radio-Electronic Servicing.

**I'LL "LEND" YOU  
THESE TWO GREAT  
MONEY-SAVERS  
For 5 Full Days**

**Save Time—Make Twice as  
Much Money . . . YOU BE THE JUDGE**

**Ghirardi's RADIO TROUBLESHOOTER'S HANDBOOK**

**Helps you repair 85-90% of all Radio  
Receiver troubles in half the usual time**

Ghirardi's big, 4 lb., 744-page **RADIO TROUBLE-SHOOTER'S HANDBOOK** is the one radio servicing short cut that really works. Eliminates much tedious testing—is worth another man in your shop! The common troubles and their remedies are carefully listed and indexed—for practically every home receiver, auto-radio and record changer in use today. The **HANDBOOK** tells exactly what the trouble is likely to be—exactly how to repair it. Ghirardi passes on to you its priceless servicing knowledge and experience obtained from thousands of hours of tedious troubleshooting and

repair work on all these receivers. By using it your service work is made **EASIER** and you can easily cut our own time in half **ON FOUR JOBS OUT OF FIVE**—and still charge the customer the same price! Think what that will mean in terms of profit! In addition, over 300 pages of this giant, manual-size book contain other invaluable data—tube charts, tube and parts substitution data, I-F alignment and transformer data, color codes and literally dozens of charts, graphs, diagrams, and compilations that will help you repair any radio ever made **EASIER, BETTER** and twice as fast! Only \$5 complete—on our 5-Day Money-Back Guarantee Basis.

**Ghirardi's MODERN RADIO SERVICING**

**All the Science of Professional Radio-Electronic-  
Television Servicing in One 1300-Page Book**

**TRAIN FAST!  
TRAIN  
RIGHT!**

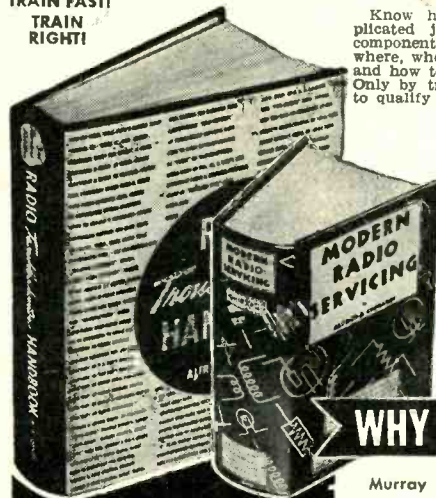

Know how to make preliminary trouble checks on complicated jobs? Know how to analyze any circuit and its components quickly and scientifically? Do you know exactly where, when and how to use all types of test instruments . . . and how to interpret their readings to track down the trouble? Only by truly professional training of this sort can you hope to qualify for the big-money work—and especially on the more complicated new FM and Television receivers.

**INCREASE YOUR EARNINGS!**

Nowhere else can you get such training faster, easier and at less cost than in Ghirardi's **MODERN RADIO SERVICING**. This 1300-page, profusely illustrated book brings you up to date on modern methods, refreshes you on any type of work that may prove puzzling, prepares you for the rich opportunities that only servicemen having the true "Know How" of their profession can grasp. Everything explained simply and thoroughly so you will understand it easily and quickly. Only \$5 complete — on our 5-DAY MONEY-BACK GUARANTEE offer.

Every cent cheerfully refunded if you're not more than satisfied!

**WHY NOT HAVE A LOOK—Now!**

Murray Hill Books, Inc., Dept. RSD-56,  
232 Madison Ave., New York 16, N.Y., U.S.A.

Enclosed find \$..... for books checked; or  send C.O.D. (in U.S.A. only) for this amount plus postage. If not fully satisfied, I may return the books within 5 days for refund.

- RADIO TROUBLESHOOTER'S HANDBOOK** \$5 (\$5.50 foreign)
- MODERN RADIO SERVICING** \$5 (\$5.50 foreign)
- MONEY-SAVING COMBINATION OFFER: Both big books — over 2040 pages — only \$9.50 for the two (\$10.50 foreign).**

Name .....  
Address .....  
City & Dist. No. .... State .....

**MONEY-SAVING  
OFFER!**

Let Ghirardi's **RADIO TROUBLE-SHOOTER'S HANDBOOK** save you time on common radio jobs. Let **MODERN RADIO SERVICING** train you in scientific electronic servicing "Know How". Get **BOTH** big books at special price of only \$9.50. Send coupon today!

And **NOW!** a "Pocket-size" OSCILLOSCOPE

# The **POCKETSCOPE**



See the  
**POCKETSCOPE**  
at the show:  
Booth 26  
Stevens Hotel  
May 13-16

- So **SMALL** in size (4" x 5½" x 10")
- So **LIGHT** in weight (5½ lbs.)
- So **COMPLETE** in performance
- So **INEXPENSIVE** in price
- Plus **WIDE-ANGLE VISION**: on shelf, on floor, on bench
- Plus **RETRACTABLE LIGHT SHIELD**: for increased visibility

## FOR DELIVERY:

Contact your nearest jobber. If he doesn't have the **POCKETSCOPE** available, contact us direct.

**\$55** net

**WATERMAN PRODUCTS CO.**  
INCORPORATED  
Phila. 25, Pa.



## FINANCE PLANS

[from page 21]

phone, mail or personal call by highly trained personnel, keeping delinquencies to a minimum. When the purchaser's account is about fully paid up, the finance company sends the dealer a prospect card as a reminder. Salesmen find these invaluable in making follow-up sales.

Each dealer's requirements are different, and finance companies which specialize in the field of installment credit prescribe the plan that fits a particular type of business in its locality. The dealer's sales and clerical personnel are instructed in the use of rate schedules, sales contracts, etc. Sales campaigns developed by the dealer are helped along with sales promotion material including folders, posters and salesmen's manuals.

## In Trade

[from page 4]

cables, etc., would be the key to our talk; instead we found that the life of this man is the story of a little belt. A little belt—a belt of woven fabric became not only a tremendous business, but a boon to every radio serviceman.

In 1936, some 35 radio manufacturers had adopted the system of dial belts. Each one had his own method of listing the size, width, length and circumference. Some manufacturers used as many as 15 different types. The result was confusion. The serviceman was faced with the problem of listing, and of the severe difficulty in securing the proper belt replacement at the right time. This difficulty was further aggravated by the fact that belts had to be replaced at least twice a year—and most manufacturers were too much involved with production to handle adequately the sale of the relatively minor item of replacement belts.

In that year Mr. Finkel began to create order out of chaos. "Why couldn't servicemen get their replacements directly from jobbers?" he asked. "Why couldn't the belt replacement business be an exclusive parts jobbers' business — every belt size available; with standard parts; with an efficient system of delivery; with complete belt kits on hand?"

Reaching back into many years of invaluable experience, JF as he is affectionately called gathered about him the radio service experts, the parts experts, the statisticians necessary to complete this task. The perspective

[see page 32]



Model A-81 Cabinet

Model A-121 Cabinet

Model A-151 Cabinet

THE FAMOUS

*\*Bass Reflex*

REPRODUCERS IN NEW,  
BETTER-THAN-EVER DESIGNS

True high-fidelity reproducers with the famous and exclusive *Jensen Bass Reflex* principle of design are now available in improved postwar cabinets. *Jensen Bass Reflex* reproducers give crisp, extended range reproduction... no back-side radiation... full bass with no boom.

*Bass Reflex* Reproducers are widely used in broadcast monitoring and in recording work. They are ideal for ham shack use and are in much demand for phonographs, FM reception, and general sound reinforcement applications.

*Jensen Bass Reflex* Reproducers are available in sizes for 8-inch, 12-inch and 15-inch loud speakers and are designed for floor or wall installation. The 15-inch cabinet is designed for both Type J and Type H *Jensen Coaxial Speakers* and for single-radiator 15-inch speakers.

Write for complete literature.

\* Trade Mark Registered

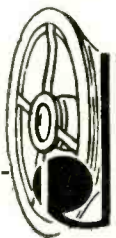

**Jensen**  
SPEAKERS

WITH **ALNICO 5**

The Jensen exhibit will be in Booth 68 at the 1945 Radio Parts Show in Chicago's Stevens Hotel, May 13th through 15th. Old and new friends alike are cordially invited to see the 1945 line of Jensen fine acoustic equipment.

JENSEN RADIO MANUFACTURING COMPANY  
6619 SOUTH LARAMIE AVENUE • CHICAGO 38, ILLINOIS  
In Canada: Copper Wire Products, Ltd., 137 Oxford Street, Guelph, Ontario

*Specialists in Design and Manufacture of Fine Acoustic Equipment*

# STOP the "wear-loss" of playing records! Modernize your Booths

Save records,  
improve sound,  
increase sales

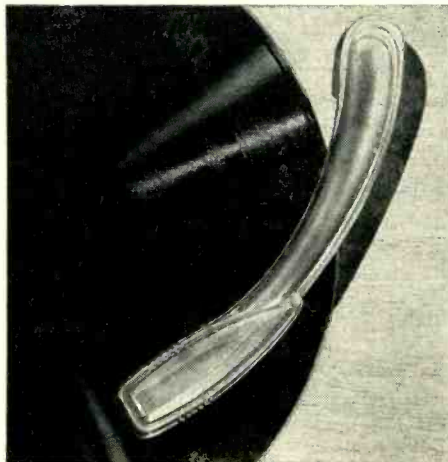

... with Shure *Glider*

Bring your pre-war phonographs up-to-date with a Shure "Glider" Pickup that saves records and needles. Needle force is only 1½ oz.—"Glider" glides along record grooves smoothly and easily. Records can be played over and over again, yet still give the clear, full tones of "first play" quality. For increased record sales replace your heavy, record-wearing pickups with the light-weight, high-output "Gliders"—at a cost of only \$3.66 a pickup.

### Extra Profit Opportunity

Your customers, too, will want a Shure "Glider," once they hear it in your playing booth. Retail for \$6.10 giving you a neat profit of \$2.44 and at the same time encouraging the sale of a permanent-point needle. Big demand, self-selling profitable item. Ask for merchandising program. Send coupon.

Patented by Shure Brothers. Licensed under the Patents of the Brush Development Company

## SHURE BROTHERS

Designers and Manufacturers of Microphones and Acoustic Devices

225 West Huron Street, Chicago 10, Illinois  
Cable address: SHUREMICRO



### MAIL THIS COUPON FOR "GLIDER" FACTS

SHURE BROTHERS  
225 West Huron Street, Chicago 10, Illinois

I am interested in modernizing my playing booths with the Shure "Glider" Pickup. Please ask your distributor to call.

I am also interested in the Shure "Glider" for resale.

Name .....

Address .....

City ..... Zone ..... State .....

### In Trade [from page 30]

was to secure from the radio industry the specification of every belt ever used; their sizes, widths, circumferences, and what have you. Further, all data had to be arranged for publication to provide a simple business for the replacement of dial belts. And then the belts had to be made—not just any belt—but the proper belt for the proper radio.

At last, a new quality had appeared in the radio parts industry. Any serviceman anywhere could call any jobber—ask for a particular belt and get it—and still be certain that it was the right belt. From the thousands of sets in use, 95 belts had been selected and standardized. A 64 page manual covering every conceivable bit of information—the length, size, width; details of every set manufactured, of every belt used—was in each serviceman's hand. And shortly after this, belts were packed in metal kits for both jobbers and servicemen.

Today, 10 years later, every parts jobber in the United States enjoys a prosperous business from the sale of dial belts. Mr. Finkel surmises that the average jobber carries a running stock of from 500 to 5,000 at all times. The little radio dial belt which sells for about 15c—has now become a business nearing the half-million dollar mark. This year, JFD expects to sell approximately 3,000,000 belts.

### Motorola Announces Specifications

The Galvin Manufacturing Corp. has released specifications of the new 1946 Motorola A-M and F-M Home Radios. W. H. Stellner, vice-president in charge of Home Products, asserts that the new radios represent vast improvements over prewar models. He cited as a primary example the improvements in the portable sets resulting from the intensive research that was necessary for the designing and building of the Motorola "Handie Talkie" and "Walkie-Talkie".

A few of the specific improvements mentioned by Mr. Stellner are: 1. Richer, more vibrant tone. 2. Outstanding selectivity and sensitivity. 3. Exquisite new cabinets, engineered for acoustic perfection by the nation's foremost designers. 4. Greatly improved F-M operation. 5. A new, patented record changer that is extremely gentle to records and which virtually eliminates "needle talk". The new changer is said to have a sturdier tone-arm and pickup that gives super-accurate record reproduction.

[see page 39]



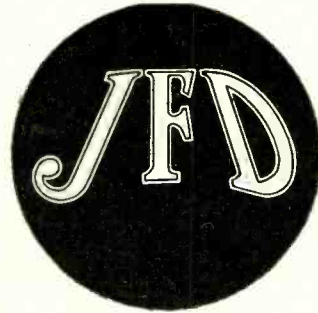
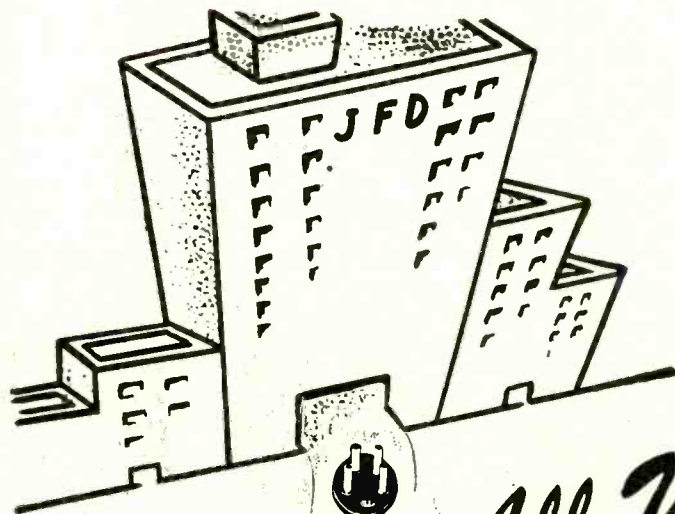

*All Under One Roof*

**W**E manufacture over 25 different lines for the Radio service trade and are prepared to ship

- JFD "SOCKETTE" RADIO TUBE ADAPTERS
- JFD EXACT DUPLICATE BALLAST TUBES
- JFD PHOSPHOR BRONZE DIAL CABLE
- JFD BATTERY ADAPTER HARNESSSES
- JFD ADJUSTABLE BALLAST TUBES
- JFD RESISTANCE CORD ADAPTERS
- JFD PHONO ADAPTER SWITCHES
- JFD MICROPHONE CONNECTORS
- JFD MIDGET JACKS & PLUGS
- JFD PHONOGRAPH NEEDLES
- JFD RESISTANCE CORDS
- JFD AC SERVICE CORDS
- JFD TOGGLE SWITCHES
- JFD AUTO CONDENSERS
- JFD SPEAKER CEMENT
- JFD ANTENNA LOOPS
- JFD AUTO ANTENNAS
- JFD BATTERY PLUGS
- JFD TUBE SHIELDS
- JFD RADIO WIRE
- JFD SUPPRESSORS
- JFD DIAL BELTS
- JFD DIAL CORD

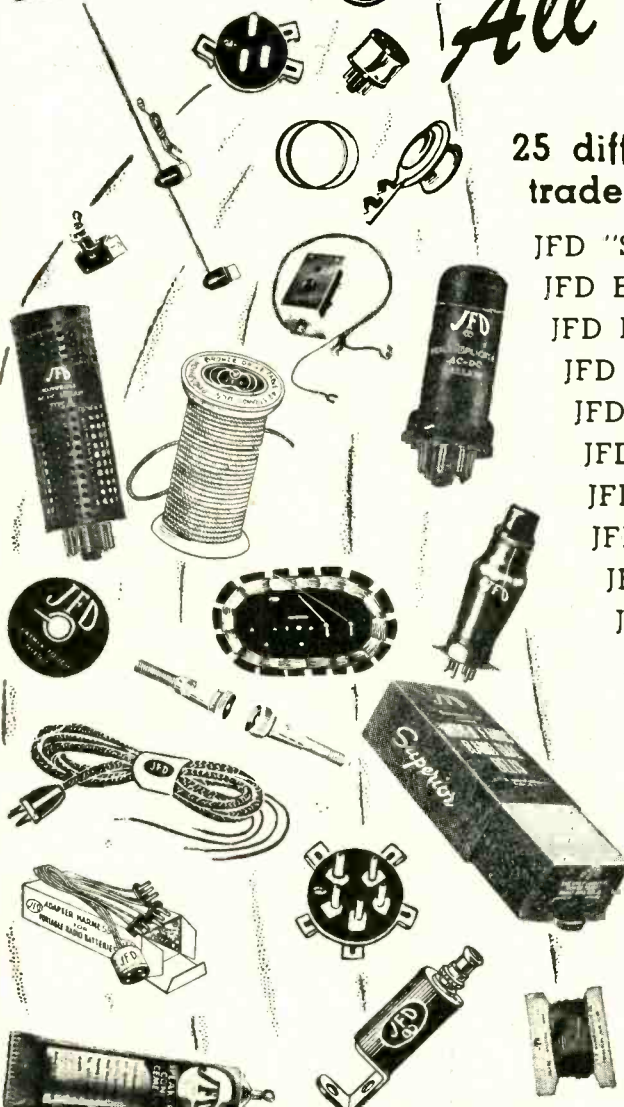

WRITE FOR LITERATURE ON ANY OF THESE UNEXCELLED PRODUCTS

*Serving the radio trade since 1929*

**J.F.D. MANUFACTURING CO.** 4111 FT. HAMILTON PARKWAY  
BROOKLYN 19, N. Y.

## DEALERS MERCHANDISE DISCS

### Autograph Stunt

The Thearle Music Company of San Diego staged a highly successful promotion of Eleanor Steber recordings with an open house for the singing star when she made a concert appearance in the California city.

As a build-up to Miss Steber's autographing stint, Manager Harry Callaway sent out formal invitations to his mailing list, and a general invitation to the public through newspaper ads.

For a week prior to her appearance, an entire show window was given over to display of RCA Victor's "Oklahoma" album recorded by Miss Steber and blow-ups of the singing star.

### Dealers Tie-In with Film

Smart promotion by Philadelphia dealers led to unprecedented sale of Perry Como's "Dig You Later" record when the 20th Century Fox film "Doll Face", from which the song was taken, ran in that city. Kick-off of the pro-



Emphasis on furniture styling is placed by Galvin Mfg. Corp. on new Motorola home radios, reports Vic Irvine, ad-manager. Dealers feature displays of radio as furniture, creating favorable reactions among customers. Cabinets are designed for acoustics first, then adapted to furniture designs which house such modern developments as the Roll-O-Matic record changer, Top-Vue tuning, etc.

motion was a preview party of the film given by Raymond Rosen, RCA Victor distributor for the area, at 20th Century Fox headquarters. Representatives from 20 Philadelphia record shops attended. To round out promotion, dealers were supplied with Como four-color blow-ups and glossy prints of stills from the movie for counter and window display.

### Rumpus Listening Room

To solve the teen age noise problem, Barnard's, RCA Victor record dealer in Kansas City, Mo., converted a large basement room into a rumpus-listening room for the high school crowd. Decorated for special appeal to the bobby sox group, the room was named "Discus Den", prize-winning title in a contest sponsored by the shop. Prize for the tag was a Hot Jazz album.

High schoolers are invited to dance, sing and let off steam generally. Although bulk of record sales come from upper floor, there is a convenient sales counter amply stocked with pop records in the "Den". Expenses for "Discus Den" have been paid out of profits of the coke machine alone.

### Merchandising Tidbits

Scheduled for early production by RCA Victor is a new booth demonstrator. The instrument will be made



## Covers the Spectrum

WITH CABLES AND CONNECTORS FOR EVERY FREQUENCY

Amphenol serves the electrical and electronic industries with the most complete line of cables, connectors, plugs and fittings for every application. No matter what the need—from high-current, low-voltage cables and connectors such as are used in power lines, to high-voltage, high-frequency components required in the upper regions of the spectrum—there is an Amphenol product for the job. Amphenol cables and connectors are used in Radar, F.M., Television, Standard Broadcast, electronic controls and equipment . . . and in numerous industrial applications.

Amphenol connectors are engineered and constructed so as to afford the absolute minimum of loss of power, potential or waveform even at the highest frequencies. These components reflect the greatest advancement in all phases of electrically correct design and mechanically correct manufacture. Amphenol makes the most complete line of cables, connectors, plugs and fittings for the most efficient transmission of power at all frequencies.



AMERICAN PHENOLIC CORPORATION  
CHICAGO 50, ILLINOIS  
In Canada • Amphenol Limited • Toronto

COAXIAL CABLES AND CONNECTORS • INDUSTRIAL  
CONNECTORS, FITTINGS AND CONDUIT • ANTENNAS  
RADIO COMPONENTS • PLASTICS FOR ELECTRONICS



available to dealers at cost. . . . Alert dealers used a Spike Jones feature in a recent issue of *Look Magazine* to promote Spike's records. The feature included a picture of Spike and the City Slickers in the Smithsonian Institute. Caption to photo and catchline for window and counter displays was the King of Corn's statement: "I have set music back 1,000 years". . . . To help the dealer keep his *Record Review* mailing lists up to date, RCA Victor has arranged to have undelivered copies returned to the dealer with subscriber's address furnished by the post office. . . . The RCA Victor single of background music to the Berman-Peck film "Spellbound," as performed by Al Goodman and Orchestra, offers tie-in opportunities with local showing of this smash hit.

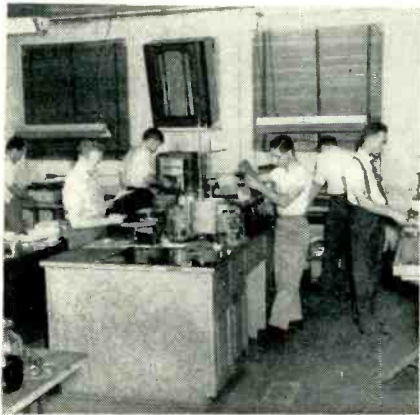

**Record Test Lab.**

Opening of new research laboratories is announced by William C. Speed, president of Audio Devices, Inc., manufacturers of Audiodiscs.

"The opening of our new laboratories", he pointed out, "is particularly timely in view of the tremendous upsurge in popularity of phonograph records and recorded radio programs. With it, we hope to obtain the answers to many of the sound-recording questions we have for years been asking ourselves. Those answers, as we find them, should form valuable contributions to the recording art; collectively they should result in a constantly improved medium for recording history in the making as well as for providing wholesome radio and phonograph entertainment for the public."

Equipped with every known modern piece of electrical, electronic and other scientific apparatus as well as numerous specially designed instruments for the study of recordings, the new laboratories will permit measurements of tone distortion, record surface noise, wearing qualities and other features with a precision never before even attempted.

The new laboratories, located at Stamford, Conn., are in charge of

Ernest W. Franck, Research Director, who joined the company in 1940.

**Record Combine**

Jefferson-Travis Corporation, which recently acquired the Musicraft Corporation, one of the larger independent phonograph record manufacturers, announced today through its president, Mr. Irving M. Felt, that it has also acquired Guild Records Incorporated. The Guild acquisition provides an ultra-modern phonograph record pressing plant in South Norwalk, Connecticut, and will contribute further to the expanding Musicraft catalog of re-

leased and unreleased masters. The Norwalk plant, together with Musicraft's Ossining, N. Y., plant which will soon commence operations, will insure record production on the Eastern Seaboard of major proportions for Musicraft which also operates a modern integrated pressing plant at Los Angeles.

**New Meck Distributors**

The Sacramento Electric and Supply Company, Sacramento, Cal., and the Nebraska Radio Distributing Company, Lincoln, Nebraska, have been added to the list of distributors for John Meck radio products.

**SERVICE DEALERS**

**LOOK AHEAD**

Every issue of "RSD" carries Service Data on the popular new radio receivers now being manufactured. These Data Sheets fit into standard manuals — should be kept until new manuals are available — every technician wants this service!

"RSD" publishes more authentic articles on new servicing methods and new test equipment than other magazines. Trouble shooting is made easier — time is saved — more jobs can be done at greater profit.

Merchandising guidance is given to Service Dealers — from the 1-man shop owner to the biggest establishment. It's important to know how other successful Service Dealers conduct their business.



**YOU GET YOUR MONEY'S WORTH EVERY MONTH**

During the past two years "RSD" has published over 305 pages of exclusive technical data . . . or about as much as the two contemporary trade papers combined. "RSD" also published over 200 pages of general interest and semi-technical material during the past two years — more than any other trade paper carried on these subjects. Besides — "RSD" carries more advertising from more manufacturers catering to Service Dealers. Subscribe to "RSD" today.

**USE THIS COUPON — FILL IN — RETURN IT TO US AT ONCE WITH YOUR REMITTANCE ATTACHED.**

**RADIO SERVICE DEALER**

12 issues \$2—24 issues \$3 in U.S.A. & Canada. Elsewhere \$3 per year.

**342 Madison Ave., New York 17, N. Y.**

Gentlemen: Please send the next . . . . . issues of RADIO SERVICE DEALER. Our remittance in the sum of \$ . . . . . is enclosed.

Name . . . . .

Address . . . . .

City . . . . . Zone . . . . . State . . . . .

Firm Employed By: . . . . .

Position or Title . . . . .

# Shop Notes

## FREQUENCY RECORDS

For a quick check of the response of a phonograph reproducing system by ear: You can easily tell when the response of the system rises rapidly, that a resonant peak exists; and that when the lower or higher frequencies are absent (compared with the response of similar sets) that the set under test warrants further check electronically. This type of test is very effective in the home of the customer before removal of his set to your shop.

This applies also to testing P.A. installations. Instead of having someone speak through the mike: "Hello, testing — 1, 2, 3, (etc.)", the record can be run off in a minute, giving the operator a full picture of the response by ear.

**Phono. Pickup Response Characteristics:** A check in variation in tone quality of one pickup compared to another can easily be verified by using an amplifier with smooth or flat frequency response characteristics. Frequency runs are easily made on phonograph reproducing sys-

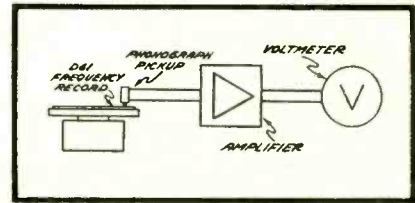

Check of phono-pickup response.

tems by disconnecting the loud speaker and inserting a resistor of an ohmage equal to the speaker impedance. Test is made by connecting the vacuum tube voltmeter across the resistor and computing the voltage ratio in decibels.

**Technical Data:** Frequency records are 12-inch, recording at 78 rpm. Recorded on one side, with an optical pattern on reverse. Disc is "pressed" in the new flexible recording stock. Will not break in shipment or handling. Recording operation in three parts. 1. The first section is a continuously rising tone of 50 to 10,000 cycles per second. Frequencies are voice announced in 15 "breaks". The range of frequencies is composed of three consecutive steps recorded at constant velocity as follows: 50 to 200 c.p.s. at + 7 DB, 200 to 500 c.p.s. at + 14 DB and 500 to 10,000 c.p.s. at + 21 DB. 2. A second section consists of 1000 cycle tone recorded in steps of 2 DB from + 8 to + 18. 3. The final section consists of a 400 cycle tone recorded at + 18 DB. Zero reference is established at an arbitrary level. ff

## YOUR PATIENCE WILL BE REPAID\*

There are good reasons for you to be patient if your jobber can't give you immediate delivery on every volume of Rider Manual. Those reasons are the same reasons that have made Rider Manuals the unchallenged leader of radio trouble-shooting reference books.

1. **Rider Manuals are the most complete.** If you are called upon to service any and all models of radio receivers, Rider Manuals are the only single source upon which you should depend for complete servicing information. They supply such vital material as receiver schematics, voltage data, alignment data, resistance values, chassis layouts and wiring, trimmer connections—in fact all the data that lead you to quick diagnosis of faulty receivers.

2. **Rider Manuals are authoritative.** They enjoy world-wide recognition because they have given world-wide satisfaction for the past 16 years.

3. **Rider Manuals are constantly being improved.** As part of our five year postwar publishing program we are de-

veloping new ideas for inclusion in Volume XV that will make Rider Manuals even more valuable as time-savers.

4. **Rider Manuals are part of a continuing service.** The findings of the staff of engineers employed in the Rider Laboratories are reported in "Successful Servicing," the technical business paper soon available free to the radio industry. It will keep them up to date in all phases of the servicing field.

Yes, Rider Manuals are the leaders for many reasons, any of which is sufficient to justify your patience in waiting for delivery. Place your order today and enjoy priority.

SEE  
PRICES  
BELOW



### RIDER RADIO BOOKS KEEP YOU UP TO DATE

OUT IN MAY!—"UNDERSTANDING MICROWAVES" \$6.00—ALSO "RADAR" \$1.00

RIDER MANUALS (14 VOLUMES)			
Volumes XIV to VII	\$15.00 each volume	The Meter at Work	\$2.00
Volume VI	\$11.00	The Oscillator at Work	2.50
Abridged Manuals I to V (1 Vol.)	17.50	Vacuum Tube Voltmeters	2.50
Record Changers and Recorders	9.00	Automatic Frequency Control Systems	1.75
		A-C Calculation Charts	7.50
		Hour-A-Day-with-Rider Series—	
Inside the Vacuum Tube	4.50	On "Alternating Currents in Radio Receivers"	
The Cathode Ray Tube at Work	4.00	On "Resonance & Alignment"	
Frequency Modulation	2.00	On "Automatic Volume Control"	
Servicing by Signal Tracing	4.00	On "D-C Voltage Distribution	1.25 each

JOHN F. RIDER PUBLISHER, INC. 404 Fourth Avenue, New York 16, N. Y.  
Export Division—Rocke-International Electric Corp. 13 E. 40th Street New York City Cable: ARLAB

\*Shipments of  
**RIDER MANUALS**

Are Increasing Each Month

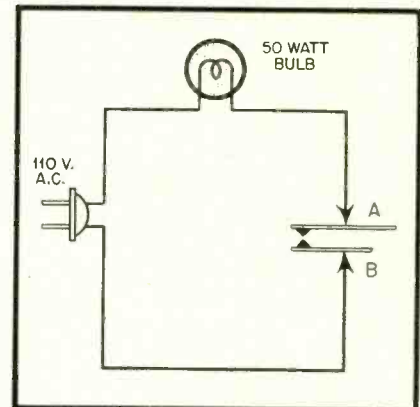

Figure 1

## VIBRATORS

Very often, vibrator contacts which have had a long shelf life will develop a non-conductive coating on the surface of the contact points. Connecting a 50 watt bulb, as in Fig. 1, in series with the armature contact A and the stationary contact B across the 110 volt power line will arc the points of the contacts and clear this coating.

## SPEAKER PHASING

In receivers, or P.A. installations, where two or more speakers are used, it

is necessary to "Phase" the speakers so that the cones move in and out at the same time. Unless this is done, acoustic cancellation will occur, resulting in poor tone and low output. Two methods of phasing are given below.

The first method is used where the voice coils are connected in parallel with each other. Connecting the 1.5 volt battery, as in Fig. 2, across the voice coils will cause them to move in or out depending on the polarity of the dry cell with respect to the windings. The direction of the cone movement can be checked by sight or touch.

A second method, suggested by R.C.A., for speakers with separate output transformers is explained as follows:

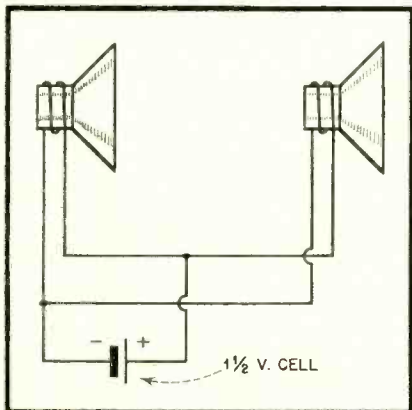

Figure 2

A pair of magnetic earphones, P1 and P2, are connected to a D.P.D.T. switch S, an A.F. amplifier, and an output meter as shown in Fig. 3. An audio signal obtained from the signal generator through the receiver is then fed into both earphones from the loud speaker, L.S., until a reading is observed on the meter M. The switch, S<sub>1</sub>, is then flipped from one position to the other. The position which results in the maximum meter reading is marked, "in phase". The other position is marked, "out of phase". In the "in phase" position of the switch, S<sub>1</sub>, the earphones are connected so that instantaneous voltages generated across both phones aid each other.

The next step is to place one phone against one of the speakers and the other phone against the other speaker. With the volume of the receiver turned up far [see page 38]

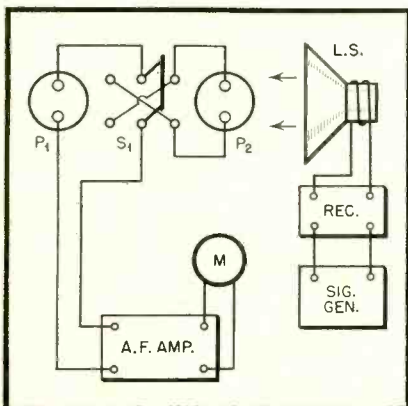
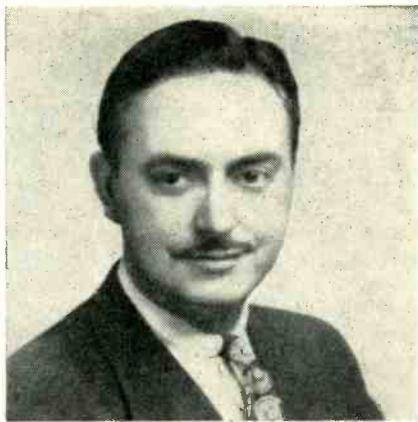

Figure 3



Jean H. DuBuque, advertising and public relations director, Lear Inc.



Theodore Hegeman, sales manager, Electronic Laboratories, Inc.



*Shuts Itself off*  
AFTER THE LAST RECORD HAS PLAYED

MODEL  
56



**WEBSTER**  
*Automatic Record Changer*

An outstanding convenience for the owner of Webster 56 is the automatic shutoff. The machine automatically stops after the last record has played . . . this is another reason why Webster 56 performs so simply and smoothly, assuring fullest record enjoyment. Makers of finer radio phonograph combinations have accepted it for use in their instruments.



Velocity trip—changes more kinds of standard records than the usual changer.  
Fool-proof operation—pick-up arm can be moved without damage while machine is in change cycle.  
Protects finest records, but it will change many old, badly worn—yet cherished—records.  
Feather-touch pickup.  
Fast change cycle.

THE CHOICE OF MUSIC LOVERS EVERYWHERE

**WEBSTER**  **CHICAGO**

5610 Bloomingdale Avenue, CHICAGO 39, ILLINOIS  
32 years of Continuous Successful Manufacturing

**BUILD  
YOUR LINE  
AROUND**

*Smooth  
Power*



For quick starting, uniform speed and quietness, equip your new phonographs and record-changers with *Smooth Power* motors. From the wide and modern GI line, accurately and carefully built, you can select exactly the right motors for your needs.

Then you'll be sure of giving your customers that smooth, all 'round performance that builds good will . . . and sales. For motors you can always depend upon, *standardize on Smooth Power.*

**THE GENERAL INDUSTRIES CO.**

DEPT. MS • ELYRIA, OHIO

**Shop Notes**

[from page 37]

enough so that the audio signal from the signal generator is loud enough to give an indication of the output meter, M, the switch, S, is flipped from one position to the other.

If the greatest output occurs in the "in phase" position the speakers are properly phased; otherwise it becomes necessary to reverse the connections to the voice coils of one of the speakers.

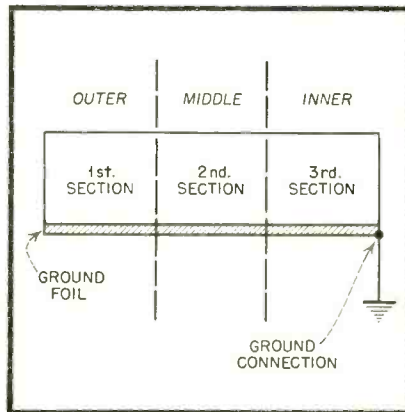
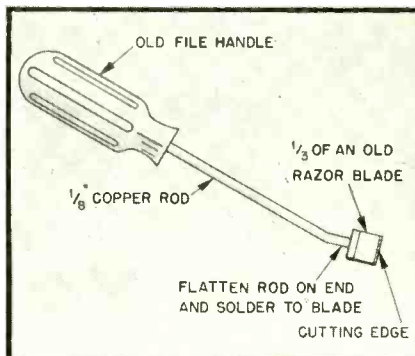

Figure 4

**CONNECTING ELECTROLYTIC CONDENSERS**

In many electrolytic condensers the ground connection foil is common to all sections. (See Fig. 4.) In a few cases, if the outer section is connected as the first filter condenser, A.C. is returned through the remaining strip of foil connecting the outer section and the ground connection connected to the 3rd or inner section. This might result in hum pickup in the other sections along the path.

It is advisable, therefore, that the condenser used as the first filter be the one nearest the ground connection. This may be determined experimentally, if hum is picked up, by interchanging the connections to the filter. Otherwise, the correct data may be secured from the manufacturer.



Above, description of a home-made tool to remove speaker cones for recentering. Cones may be removed with one motion. For best results, use a cut pry, cut pry action. This works much more speedily than the only other way I know which involves messy use of cement solvents.

R. M. Sickels, Ind.

**DEPENDABLE!**

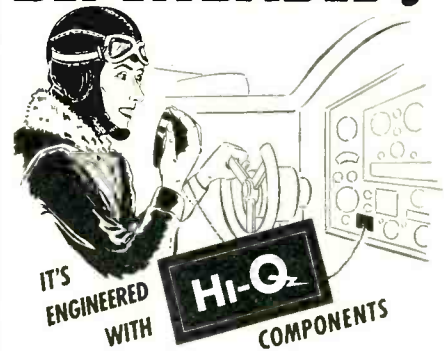

Made right . . . to work right . . . and stay right. Whether in stock ratings or to your own specifications you will find Hi-Q components precise, dependable and long lived. Send for samples and complete information.

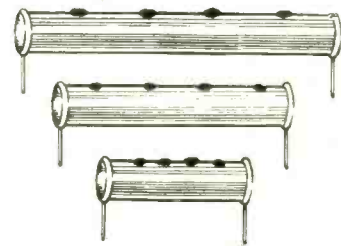

Hi-Q Ceramic Capacitors are of titanium dioxide (for temperature compensating types) and are tested for physical dimensions, temperature co-efficient, power factor and dielectric strength. CI type with axial leads; CN type with parallel leads.

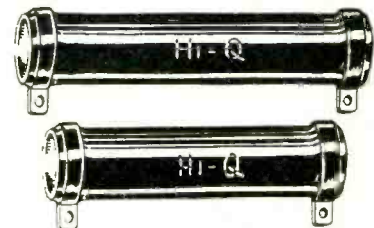

Hi-Q Wire Wound Resistors can be produced promptly and in quantity — with quality physical specifications and high performance electric specifications.

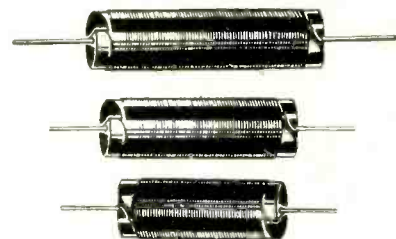

Hi-Q Choke Coils are uniform in their high quality performance. Ruggedly constructed for long service.

**ELECTRICAL REACTANCE CORPORATION**  
FRANKLINVILLE, N. Y.

## CONVERTING DC SETS

[from page 15]

or a total of 18.9 v. The pilot light drops 6 v. The two 43s drop 50 volts. The 25Z5 or 'Z6 drops 25 volts. The total voltage dropped is 99.9 volts.

If we assume that the line voltage is 115, 115-99.9 or 15.1 volts remain to be taken care of. The resistor needed would be equal to  $E/R$ , or  $15.1/.3$ , or approximately 50 ohms. Its watts rating would be  $I^2R$ , or  $50 \times (.3)^2$  or about 5 watts.

Another example of a dc set that can be readily converted to ac-dc operation is the Emerson model L-DC-4. Three of the four tubes present—the 2 39s and the 36 have indirectly heated cathodes. The fourth—the 33—is a direct-heater type. One of the 39s may be used as a half-wave rectifier, by tying plate and grid together. The 33 may be replaced by a 38, which has an indirectly-heated cathode. The rewiring of the filament circuit is simple (see Fig. 5).

Other changes would include the replacement of the 33's cathode resistor by one suitable to a 38; and the changing of the chokes and filter condensers, if the ones present are unsuitable because of insufficient inductance and capacitance. The field coil may be attached in any of the ways suggested above.

## In Trade

[from page 32]



H. W. Sams (right) discusses the new "PhotoFact" Folder service with P. R. Mallory, chairman of the board, P. R. Mallory & Co. Inc. (see p. 24).

## New Speakers

In order to provide additional facilities for the manufacture of speakers for which there is a sizable backlog and a growing demand, Cinaudagraph Speakers, Inc., has been transferred from Chicago to Slater, Missouri, announces R. C. Walker, president of  
[see page 45]

# Thank You!

Your cooperation has made it possible for us to grow. Now we are moving to our own newly erected and completely modern building where we will be able to serve you with ever better models and increased production.

Please address all future orders and correspondence to us at our new address...



## PRODUCERS of:

- Variable Resistors
- Selector Switches
- Ceramic Capacitors, Fixed and Variable
- Steatite Insulators
- Silver Mica Capacitors

# Centralab

Division of GLOBE-UNION INC., Milwaukee

## Converter, Mixer and Oscillator Circuit Applications

[from page 18]

electron reaches the electrode it originally set out for. In this case it comes

to rest first, following which it reverses its direction of movement and

proceeds back towards the cathode. As a result the circuit becomes inoperative.

The solution is to use tubes designed so that even at high frequencies no transit time reversal of electrons within the tube takes place. Acorn tubes of the 955 type are an example of these tubes. At frequencies above 500 megacycles it becomes necessary to use tubes of more special design, such as the Klystron and Magnetron. The latter is now being used in services around 10,000 megacycles.

Frequency *shift*, mentioned previously as the effect of terminal voltage variations, can be minimized by using voltage regulated power supplies, and tubes in which these effects produce negligible frequency changes, such as the 6K8. Circuit arrangement and design also have a great deal to do in reducing this effect.

Frequency *drift*, caused by changes in temperature and humidity, can be minimized by using high quality insulators and dielectric materials. As previously pointed out, compensating networks like the one shown in Fig. 11 aid materially in obtaining stable operation at the ultra-high frequencies.

As the frequency increases, the tube leads begin to take on properties of inductance and capacitance. This materially affects the resonant frequencies of these circuits. One of the most serious sources of trouble along these lines is the cathode lead. However, the use of R.F. chokes inserted in the cathode circuit eliminates these resonant effects to a great extent. See Figs. 13 and 14. Other similar sources of trouble are the leads in the external grid to cathode, and plate to cathode paths. Obviously, the only solution for the condition just described is to lay out the parts in such a manner as to insure the shortest possible leads. Modern u.h.f. stages are small, compact units wired in this manner.

The need for a tuning device with a low capacity and a wide tuning range has led to the development of the so-called *Butterfly* units. The latter is essentially a variable condenser designed and constructed so that there is a minimum of high frequency losses in the condenser itself, as well as a minimum of residual inductance. An application of this device in an ultra-high frequency oscillator circuit is shown in Fig. 14. The latter consists, essentially, of a dual variable condenser connected in a Colpitts circuit. The inductance is the condenser frame itself constructed in a special manner.

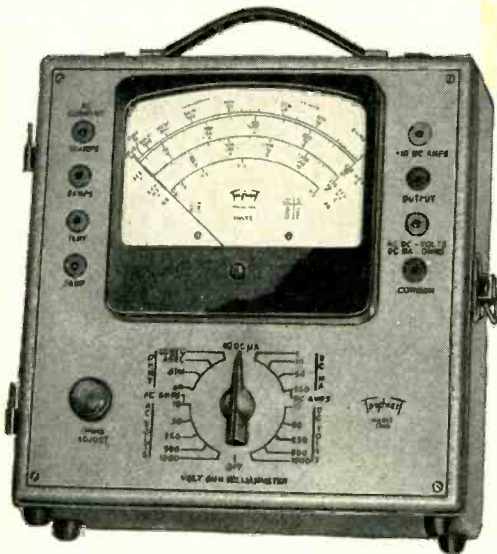

MODEL 2405

# Volt • Ohm Milliammeter

25,000 OHMS PER VOLT D. C.

STANDARDS ARE SET BY



### SPECIFICATIONS

NEW "SQUARE LINE" metal case, attractive tan "hammered" baked-on enamel, brown trim.

■ PLUG-IN RECTIFIER — replacement in case of overloading is as simple as changing radio tube.

■ READABILITY — the most readable of all Volt-Ohm-Milliammeter scales — 5.6 inches long at top arc.

Model 2400 is similar but has D. C. volts Ranges at 5000 ohms per volt.

Write for complete description

# Triplet

ELECTRICAL INSTRUMENT CO.

BLUFFTON OHIO

### NEW ENGINEERING NEW DESIGN • NEW RANGES 30 RANGES

Voltage: 5 D.C. 0-10-50-250-500-1000  
at 25000 ohms per volt.

5 A.C. 0-10-50-250-500-1000  
at 1000 ohms per volt.

Current: 4 A.C. 0-.5-1-5-10 amp.

6 D.C. 0-50 microamperes—  
0-1-10-50-250 milliamperes—  
0-10 amperes.

4 Resistance 0-4000-40,000 ohms—4-  
40 megohms

6 Decibel -10 to +15, +29, +43,  
+49, +55

Output Condenser in series with  
A.C. volt ranges

## SPEED UP REPAIRS WITH THESE G-C AIDS!

### G-C is HEADQUARTERS for RADIO PARTS and SERVICE AIDS



All Types  
of Radio  
Cements,  
Chemicals,  
Coil Dopes,  
Compounds.

G-C leads the field in supplying Radio - Electronic Manufacturers and Service Men with Parts, Tools, Radio Cements, Chemicals and Compounds. Insist on Genuine G-C Quality.

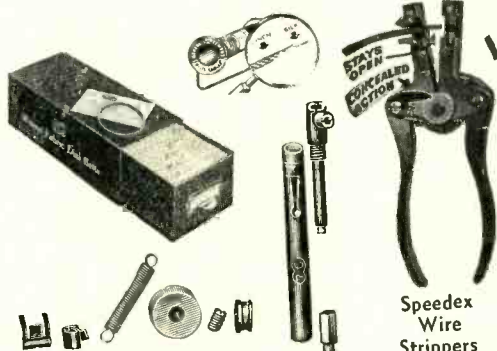

Dial Cables, Dial Belts,  
Packaged Hardware,  
Cabinet Repair Kits

Speed  
Wire  
Strippers

Alignment Tools  
Ne-O-Lite Testers

Order from Your Jobber — Send for G-C Catalog



## GENERAL CEMENT MFG. CO.

ROCKFORD, ILLINOIS



## CIRCUIT COURT

[from page 26]

loop because the short wave secondary is in series with the loop. The more complicated switching is probably compensated for in better performance than is possible with the simpler circuits. This is as simple method of obtaining band-spread as has been found.

In the new *Stewart-Warner* line of sets we find use being made of a scheme which deserves mention, and which will doubtless be found in more receivers as time goes on. Reference has been made to the fact that with the common types in which the loop is in the grid circuit of the first tube there is every possibility of line and other noises as well as unwanted signals appearing on the grid. Once they get there it is almost axiomatic to say that some interference will result in the output. Fig. 8 indicates the simple application of a transformer between the loop and the grid. With a good iron core transformer it is possible to use a low impedance loop which will be less subject to noise pick-up and still apply a substantial signal to the grid. Provision for an external antenna is made by the use of a small capacitor coupled to the loop.

An elaboration of the circuit explained above is found in the *Stewart-Warner* models 9001, 9002 and 9000B. Partial circuits for these sets are shown in figure 9. It will be observed that the loop is center tapped and the tap grounded. This should balance some noise to ground. A coupling coil is provided for an external antenna and the primary of the short wave transformer is in series with it. These sets have an RF stage on the broadcast band but switch it out on short waves. The tuning condenser of the mixer is used for both bands. Iron cores are used in all transformers. Push buttons are also provided in these sets but the details of the circuit have been simplified for this discussion and the fixed-tune portion has not been shown.

Only the simpler circuits have been used to illustrate the point that though many variations are possible, they generally fall into a few classes. More elaborate sets will be treated in later issues of RADIO SERVICE DEALER.

### Motorola Service and Parts Department

Tim Alexander, who handled Galvin Mfg. Corporation's wartime government heater contracts and contract terminations, is now managing the new Motorola Service and Parts Department. His present program calls for a field service group for dealer and distributor assistance and for a television education program. He will also reactivate the over eight thousand Motorola Authorized Service Station Group, as well as supervise the Publications and Parts Department.

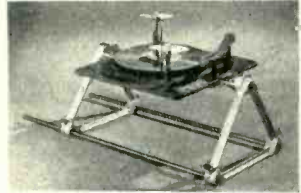
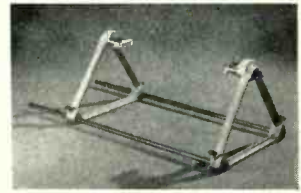
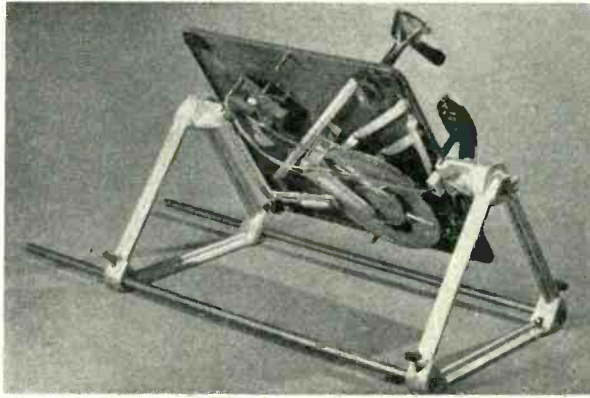

## CHANGERAK

### Speed Up Record Changer Repairs!

The Changerak is the finest record-changer rack available to servicemen. It sets up quickly and positions the work where you want it. The rigid aluminum triangle frames are instantly adjustable to any size changer. Two clamps secure the record-changer so that it may be rotated a full 360°. Locks at any convenient angle. The Changerak will definitely reduce bench-time on every job and its low cost will be repaid time and time again in work saved. Changeraks are built for years of good service. At present we are making immediate delivery.

Dealer net price F.O.B. Chicago —  
Shipping weight — 7 lbs.

**\$11.95**

Terms: 2% Check with order or 25% deposit and  
balance express C.O.D.

**HOLLANDER RADIO SUPPLY CO.**  
549 West Randolph Street Chicago 6, Illinois

**OLSON** brings you the amazing new time-saver tool...

## PHILCO'S ALL-PURPOSE Radio Pliers

**FOR WIRING  
JOBS!**

**Philco's No. 1  
Wiring Secret!**

**No change in grip—  
No other tools needed**

The experts use these all-purpose Pliers for faster, easier, better wiring. Try it—the perfect "all in one" tool for cutting wire, removing insulation, wrapping wire, trimming excess. You'll say it's a crackerjack!

**PRICED ONLY  
\$1.95  
POSTPAID**

Write for our monthly  
**BARGAIN CATALOGS**  
They're free!

**OLSON RADIO WAREHOUSE**  
73 E. Mill St. Dept. 26, Akron, Ohio

Stock X-33

Send me.....All-Purpose Radio Pliers @ \$1.95 postpaid. I enclose  
\$..... (No C.O.D. Orders.)

**NAME** .....

**ADDRESS** .....

**Order Yours TODAY**

This offer good only in U. S. A.

Where stability  
takes top priority...

# SNYDER

Antennas

**SNYDER MFG. CO.**  
PHILADELPHIA  
**MANUFACTURERS... START TO FINISH**

## LEAD-IN LINES

[from page 19]

400 to 500 feet. Choice of antenna location is also dependent upon reflection from surrounding objects. Hence it may be necessary to locate an antenna in the most unobstructed portion of the user's roof.

Commercial television signals at present cover a frequency range from 50 megacycles to 260 megacycles over several band-widths. At the high frequencies the dangers of signal attenuation and distortion are very real. If the antenna receives a faithful reproduction of the televised scene, it is important that the lead-in cable brings to the television receiver a faithful reproduction of the character of the energy received. Attenuation of the signal is a function of the design of the lead-in cable with respect to geometry, materials and relation to impedance of antenna and receiver. Signal distortion is a function of the impedance mismatch between lead-in cable and receiver and antenna.

For short lead-in cables, distortion is apparently not an important factor so that relatively large mis-matches in impedance may be tolerated. However, it is still important that attenuation be kept at a minimum, since in general the signal strengths are low and most television receivers operate near their noise limits. For the long lead-in cables both distortion and attenuation are important factors and more consideration must be given to proper cable design.

## HANDLING OF ATV LINE

The type ATV line designed by this company is a two-wire polyethylene insulated cable intended for use as television lead-in line between antenna and receiver in moderately long lead-in runs. It is non-shielded and its therefore of utmost simplicity. The cable is both rugged and flexible. It has an attenuation of 0.75 db/100 feet and an impedance of 300 ohms at 50 megacycles which gives it broad-band characteristics. This cable is designed for direct installation from the overhead antenna along the roof structures and into the building.

Although the characteristic impedance and attenuation of such cable will be affected by installation and weather conditions, for the short runs required in home use the net effects upon the picture quality are negligible. The reason for changes in attenuation and characteristic impedance with installation and weather is due to the lack of shielding. Installation in general will increase the inter-conductor

Raytheon tubes give peak performance. They have been built to this high level of maintained quality through continual testing and research by a company that is recognized everywhere as one of the advanced guard leading the way into the new era of electronics.

**RAYTHEON**  
MANUFACTURING COMPANY

*Excellence in Electronics*  
RADIO RECEIVING TUBE DIVISION  
NEWTON, MASS. • CHICAGO

capacitance and decrease the impedance. Rain and snow have a similar effect.

For long lead-in line applications, there are two types of television cable projected. One of these is a modification of the type ATV cable described above in that the conductors are heavier and the polyethylene wall is somewhat heavier. The second design contemplates use of a shielded twin cable. For this purpose a 200-ohm twin cable complete with copper braid shielding and vinyl chloride compound overall jacket is proposed. This cable has an attenuation of 1.75 db/100 feet and impedance of 200 ohms at 50 megacycles.

However, these properties are fixed and will not vary with installation and weather conditions. This cable has the further advantages that impedance matching between antenna and receiver when once made is permanent, so that phase distortion is eliminated. The cable has a further advantage in that it is covered with a non-inflammable jacket and hence will meet all Underwriter's requirements in this regard. The signal-to-noise ratio of these shielded ATV cables are larger than for the non-shielded lines.

It is possible that the type ATV line may find use in application other than television and F.M. lead-in line. Whenever a twin circuit of high characteristics impedance and low attenuation is required the type ATV line is relatively inexpensive.

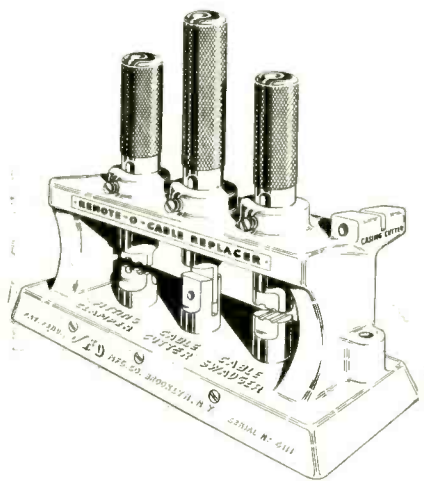

#### CABLE REPLACER

A new model Remote-O-Cable Replacer is announced by JFD Manufacturing Co., 4111 Ft. Hamilton Parkway, Brooklyn, N. Y. The machine swages shafting to prevent unraveling, cuts shafting to exact length and replaces old and new fittings on new shaftings. It allows individual servicemen to handle any problems involved in using flexible cable. With this tool the serviceman can cut shafting to any length desired, fit shafting to any automobile dashboard head and provide radio control in any part of a car.

## G-E TUBE CHECKER

Quick, easy accurate tube checking which saves you time and trouble and keeps your customers happy—that's the job the TC-3P is built to do. Line Voltage and tube quality, or shorts, may all be checked on one selector switch. Individually operated switches permit placing the proper voltage on the proper pin of the tube. The G-E Tube Checker is available in either the Portable (TC-3P) or Counter Model (TC-3). Write: Specialty Division, Electronics Department, General Electric Company, Syracuse, New York.

**GENERAL ELECTRIC**

177-D1

Electronic Measuring  
Instruments

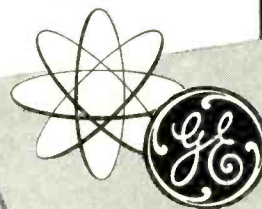
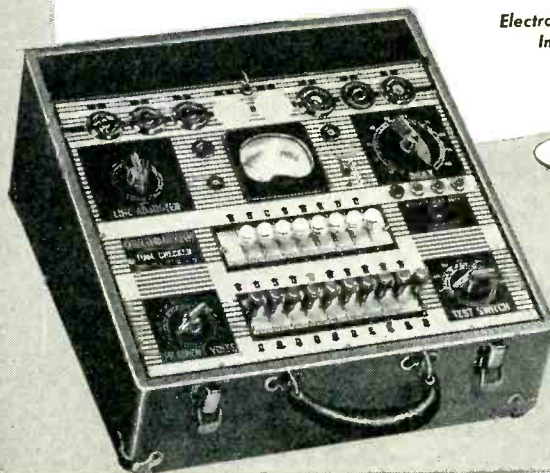

**TC-3P**

## LOCATE RADIO TROUBLE FAST with FEILER SIGNAL ANALYZER

Permits following signal directly as it progresses through any radio set or amplifier using latest type of high gain miniature vacuum tube (1T4) that allows direct connection directly across r.f. circuits with minimum detuning.

Is portable and self-contained, has own batteries. So compact that it can be carried in palm of hand. In sturdy, brown-metal finished case measuring 6 1/4" x 4 1/4" x 3 3/4" weighing 4 pounds complete with batteries.

Has special built-in network reducing input capacity from 8 to 10 times that of other instruments. Probe is of smallest size measuring 1" in diameter by 4 1/4" long with non-breakable bakelite and extra-heavy 3 ft. rubber covered cable.

Has high input impedance and can be used with any pair of magnetic phones of 1000 ohms or more. Requires no changing of switches, controls or test leads to receive r.f., i.f., or audio signals at any point in radio sets.

Model TS-1 Complete with Tube, but less batteries and phones.....Net, \$9.85  
67 1/2 Volt Battery.....\$1.60  
Flashlight Cell.....\$.06  
2,000 Ohm Dual Headset.....\$2.25



Only  
**\$9.85**

### Crowe Modern Slide Rule Dials



Esentecheon with Crow-glass Crystal, antique bronze finish, complete with pilot light sockets.

Overall Dim.  
Model 341—\$3.23 ea. .... 3 1/4" x 8 7/16"  
Model 339—\$2.85 ea. .... 3 1/4" x 6 5/8"  
Model 534—\$1.33 ea. .... 2 7/16" x 4 1/2"  
Model 585—\$1.56 ea. .... 1 1/4" x 5 1/2"

### AUTO ANTENNAS

1. Seamless Brass Tubing
2. High Polished Chromium Plating
3. Stainless Steel "Snap Back" Top Rod
4. Heavily Insulated Shielded Loom Lead
5. 100% Low Loss Construction
6. Sturdy Quality Design and Workmanship

96" \$3.49 ea. 10 or more \$3.25 ea. Lots of 100 \$3.00 ea.  
66" \$2.75 ea. 10 or more \$2.50 ea. Lots of 100 \$2.25 ea.

#### SPECIAL

Outside aerial kits consisting of:  
Antenna wire—Lead-in wire—Glass Insulators—Nail knobs—Lead-in strip—Ground clamp—Screw eyes—79c ea.  
Lots of 10 or more.....**69c** ea.

WE HAVE IN STOCK A COMPLETE LINE OF RADIO TUBES  
FOR IMMEDIATE DELIVERY

Quantity limited. All orders accepted subject to prior sale.

# RADIO PARTS COMPANY

612 W. Randolph Street

Dept. D

Chicago 6, Illinois



*A real choice...*

● Once again you have an outstanding choice of electrolytics whereby to handle any initial-equipment or replacement job properly. The new Aerovox postwar catalog lists many different types of electrolytics — those sizes, containers, mountings, terminals, voltages, capacitances and combinations you may require. ● Ask our jobber for the new Aerovox catalog — or write us.



**FOR RADIO-ELECTRONIC AND INDUSTRIAL APPLICATIONS**

AEROVOX CORP., NEW BEDFORD, MASS., U.S.A.  
Export: 13 E. 40th St., New York 16, N.Y. • Cable: 'ARLAB'  
In Canada: AEROVOX CANADA LTD., Hamilton, Ont.

**ADDRESS CHANGES—**

Subscribers to RSD should notify our Circulation Dept. at least 3 weeks in advance regarding any change in address. The Post Office Dept. does not forward magazines sent to a wrong address unless you pay additional postage. We cannot duplicate copies of RSD sent to your old address.

RSD Circulation Dept.

**Cowan Publishing Co.**  
342 Madison Ave., New York 17, N. Y.

**MEN IN THE NEWS**

[from page 29]

Consisting of a specially-equipped single-engined Waco cabin plane, a technician when needed, and such sales or service material as may be required by given circumstances, the airborne service unit, Pell explained, will permit brief or extended trips on short notice to all parts of the country. He estimates, he said, that he will cover at least 50,000 miles this year on such service calls as the following:

1. Aid in the solution of problems encountered by broadcasting stations with respect to proper use of various type recording discs.
  2. Help new FM stations to establish proper recording setups. Here, spot technical service, often needed in a hurry, may prove invaluable.
  3. Demonstrate techniques of sound recording in audio-visual training at schools and teachers' conventions. Thirty-two states are now laying plans for statewide educational radio networks in which recording studios will play important roles.
  4. Educate radio parts distributors and radio service men in recording techniques, so that home recorders, when released, will give maximum service and satisfaction to their users.
- In general, Pell explained, the chief virtue of the airborne service unit is that it will permit him and his company to give many more times the service per manpower hour than could be rendered through use of other transportation methods.



**"FREEZE" ORDER**

Benjamin Gross (seated), president of Gross Distributors, Inc., N. Y., signs what he called the "largest single order ever placed by a wholesale distributor in the history of the frozen food cabinet industry" while Harold S. Schaefer, president of Schaefer, Inc., Minneapolis, Minn., manufacturers of the Pak-a-way line of food-freezers for home, farm & industry, looks on.

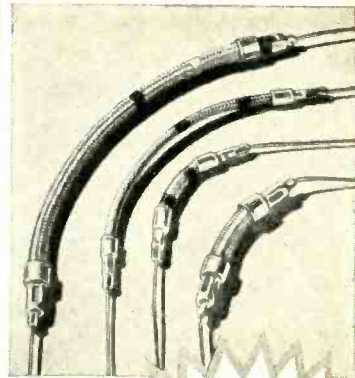

**GLASOHM**  
*flexible resistors*

★ These handy glass-insulated miniature resistors are available to servicemen. Wire winding on fibre glass core. Braided fibre-glass covering. Flexible. Just the thing for tight spots. Standard 2-watt listings from 5 to 2000 ohms. 1" body length with 2" pigtails. Inexpensive.

*Ask Your Jobber . . .*

Ask for these handy Glasohms which are unique with the Clarostat line of resistors, controls and resistance devices. Ask for Clarostat postwar catalog — or write us.



CLAROSTAT MFG. CO., Inc. • 285-7 N. 6th St., Brooklyn, N. Y.

**\$1.00 PAID FOR SHOP NOTES**

Write up any "kinks" or "tricks-of-the-trade" in radio servicing that you have discovered. We will pay \$1 for such previously unpublished "SHOP NOTES" found acceptable. Send your data to "Shop Notes Editor," RADIO SERVICE DEALER, 342 Madison Ave., New York 17, N. Y. Unused manuscripts cannot be returned unless accompanied by stamped and addressed return envelope.

## In Trade

[from page 39]

the parent company, Aireon Manufacturing Corporation, of Kansas City.

Aireon will maintain a complete speaker research department for the exclusive use of Cinaudagraph Speakers, Inc., supervised by Charles Perry in its Kansas City plant. This department has already developed several

new and improved speakers and in the near future, a complete line of Cinaudagraph Speakers will be ready for delivery.

### Record Catalog

The 1946 Columbia catalog is being distributed to dealers throughout the country. It is the largest ever to be issued by the firm. Cross indexed for ready reference, it is a veritable encyclopedia of the finest in recorded music. With the lifting of the recording ban, Columbia released a considerable number of new recordings during the past year so that the general alphabetical section which contains both Masterworks and Popular selections, offers much wider choice than ever before. In addition to the alphabetical listing you can find at a glance Ballet Music, Band Music, Drama, Educational Records, Organ Music, etc. Also included is a handy pronunciation guide, a glossary of musical terms, and biographies of Columbia's great artists. An innovation this year is the inclusion of all new Masterworks releases through December 31, 1945.

### New and Replacement Tubes For Television

As a practical contribution to post-war television, Allen B. DuMont Laboratories, Inc., Passaic, N. J., are offering a choice of cathode-ray tubes in both the electrostatic and the magnetic deflection and focusing types, and in the 5", 7", 10", 12" and 20" sizes. Still another size, the 15" tube with magnetic deflection and focus, will be added to the present selection shortly, after it has completed its developmental stage.

In addition to supplying the more significant characteristics of each tube type, DuMont engineers are also providing data on the useful picture area, as follows:

5" tubes	.....	3 x 4"
7" tubes	.....	4 x 5 $\frac{3}{8}$ "
10" tubes	.....	6 x 8"
12" tubes	.....	6 $\frac{5}{8}$ x 8 $\frac{7}{8}$ "
20" tubes	.....	12 x 16"

Relatively flat faces are used in all of these types. For instance, there are 5" and 7" tubes with 24" radius screens. The 10" tube has a 42" radius, which means a relatively flat face of good picture area. The huge 20" tube has a 30" radius. This last-mentioned tube with a useful picture of 13 $\frac{1}{2}$  x 18" is designed for direct-viewing, large-screen television receivers of the de-

[see page 47]

**IN STOCK**  
for immediate delivery

**Hytron Tubes**  
**Bright Star Batteries**  
**Cornell-Dubilier Cond.**  
and other accessories!

*Rush orders handled same day.*

**B & D DISTR. CO.**  
639 Tompkins Avenue  
Staten Island 5, N. Y.

**Ted McElroy**

World's Largest Manufacturer of  
Wireless Telegraphic Apparatus

COMPLETE CENTRAL OFFICE EQUIPMENT

**McElroy Manufacturing Corp.**  
82 Brookline Avenue • Boston, Massachusetts

**PREVORE** Est. 1930  
Now Shipping



**CHROME**  
Electric Broilers  
Inquire Now!  
Broiler Pioneers  
**PREVORE ELEC. MFG. CO.**  
126 - 18 St., Bklyn., N.Y.

**18 YEARS IN RADIO**

**GET THIS**  
*New* **CATALOG**  
By This Old Firm



Latest developments in radio and electronic parts and devices, newest ham gear, gadgets for experimenters, bargains in war surplus items.

**FREE TO YOU**

Mail the coupon below and get this new catalog FREE.

**BURSTEIN-APPLEBEE CO.,**  
1012 McGee, Kansas City 6, Mo.

Send me FREE catalog advertised in Radio Service Dealer

I AM \_\_\_\_\_

STATE CONNECTION IN INDUSTRY \_\_\_\_\_

NAME \_\_\_\_\_

ADDRESS \_\_\_\_\_

TOWN \_\_\_\_\_ STATE \_\_\_\_\_

**BA**

## Highest Quality RADIO & ELECTRONIC TESTING EQUIPMENT

Immediate Delivery from Stock  
Guaranteed

R.C.P. Model 448 Pocket Multitester.....	\$24.01
R.C.P. Model 424A Volt-Ohm-Milliameter..	\$28.91
R.C.P. Model 461A Sensitive Multitester..	\$38.71
R.C.P. Model 664 Electronic Voltmeter....	\$45.00
R.C.P. Model 705 Signal Generator.....	\$48.51
R.C.P. Model 802 N Combination Tube & Set Tester .....	\$58.31
R.C.P. Model 488A Ultra-Sensitive Multitester .....	\$70.07
R.C.P. Model 668 Vacuum Tube Volt Ohm Capacity meter .....	\$73.01
R.C.P. Model 805 Tube & Set Tester.....	\$87.71
R.C.P. Model 665A V.T. Volt Ohmmeggor .....	\$92.61
Insulation Tester .....	\$97.50
Monitor Crystalline Signal Generator....	\$52.50
McMurdo Silver Model 904 Capacitance Resistance Bridge .....	\$49.90
McMurdo Silver Model "Vomax" .....	\$59.85
Relner Model 530 Squarewave Generator...	\$95.00
Relner Model 450 Vacuum Tube Volt-Ohm-Milliameter .....	\$135.00
Superior Model CA-11 Signal Tracer.....	\$18.75
Superior Model 1553 Volt Ohm Milliameter	\$24.75
Superior Model 680 Volt Ohm Milliameter	\$27.65
Superior Model PB-100 Volt Ohm Milliameter .....	\$28.40
Superior Model 450 Tube Tester.....	\$39.50
Superior Model 650 Signal Generator.....	\$48.75
Superior Model 720 Multi-Range AC Ammeter .....	\$49.50
Superior Model 400 Electronic Multi-Meter	\$52.50
Superior Model 600 Combination Tube and Set Tester .....	\$62.50
SHALLCROSS Decade Resistance Boxes....	\$13.50
SHALLCROSS Portable Galvanometers .....	\$24.00
SHALLCROSS Model 630 Wheatstone Bridge	\$60.00
SHALLCROSS Model 637 Kelvin-Wheatstone Bridge .....	\$80.00
SHALLCROSS Model 638-2 Kelvin-Wheatstone Bridge .....	\$120.00
VM-Model 200-B Record Changer	
List Price \$37.50 .....	net \$22.50

### Special!



### THE NEW "MAGUIRE" 2-Post Automatic RECORD CHANGER Model ARC-1

List Price Dealers .....	\$47.41
Net Price .....	\$27.50
Lots of 6 or more.....	\$25.00

Write for our FREE  
new POST-WAR CATALOG!

**Metropolitan**  
**ELECTRONIC & INSTRUMENT CO.**  
Dept. **RD** 6 MURRAY STREET  
NEW YORK 7, N. Y., U. S. A.  
Phone: BArlay 7-5556  
Cable Address: METRONICS

**Order from LAKE!  
You'll Make No Mistake!**

**RADIO CABINETS & PARTS**

**NOW AVAILABLE!**

**Postwar  
2 Post  
RECORD-  
CHANGER**



With luxurious brown leatherette portable case, 15" L. x 15" W. x 10" H.

D. Latest electronic developments make this modern record-changer the finest on the market today!

List price .....\$49.95  
Dealer's net ..... 29.97

**DE LUXE RECORD-CHANGER and  
AMPLIFIER CASE**

De luxe changer case with ample room for amplifier. Overall dimensions: 20" L. x 16" W. x 10" H. Sturdily built of 3/8" plywood, de luxe brass hardware throughout. Inside dimensions: 15 1/2" L. x 14 3/4" W. x 9 1/2" H.

Net ..... **\$12.95**



**DeLuxe  
PHONO  
CABINET**

Covered in luxurious, genuine brown leatherette, has deluxe brass hardware

throughout, made completely of plywood with brown plastic handle, has padded top and bottom. Motor board 14" x 14 1/2". Overall dimensions 16" L. x 15" W. x 8" H. Your net price ..... **\$8.95**

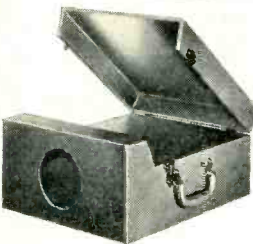

Portable Phono-graph case in brown leatherette covering. Inside dimensions 17 1/2" long, 13" wide, 7 1/2" high. Has blank motor board and opening for speaker. As illustrated at left, specially priced at .....

**\$7.95**

Also blank table cabinets of walnut veneer in the following sizes, with speaker opening on left front side: (\*Note: \*7 has center speaker grill.)  
#1 - 8 1/4" L x 5 1/2" H x 4" D \$1.95  
#2 - 10 1/4" L x 6 3/8" H x 5" D \$2.75  
#3 - 13 1/4" L x 7 3/8" H x 6 1/4" D \$3.25  
#7 - 10 1/4" L x 7" H x 5 1/2" D \$2.50  
\*Speaker Opening in center of front side.

All types of radio cabinets and parts are available at Lake's Lower prices. A large stock is listed in our catalog.



**SERVICEMEN—RETAILERS**  
Join our customer list today  
Dept. E

**Order our New Catalog Today!**  
**Get on our mailing list!**

**Lake Radio Sales Co.**  
**615 W. Randolph Street**  
**Chicago 6, Ill.**

**SERVICING DATA**

[from page 24]

preparing the "PhotoFact" Folder on each receiver. This type of procedure will be used on every set covered by its service folders, instead of the common practice of guessing at the construction of the set from the manufacturer's schematic and service notes.

The benefits which are confidently expected to result to set manufacturers, parts manufacturers and distributors from this new type of service are summarized by Mr. Sams as follows:

"For the set manufacturer, we will provide independent analysis of the electrical and mechanical characteristics of all his models; we will assure him nation-wide distribution of complete service data at the expiration of the RMA 90-day guarantee period and will make possible correct servicing of his sets; we will provide the manufacturer with the means of circulating service data on 24-hours notice to correct errors in assembly and construction.

"For the component parts manufacturer, we will provide accurate replacement recommendations for every new receiver manufacturer after January 1, 1946 and will list his parts as available replacements wherever tests prove they are satisfactory for the requirements.

"For the parts distributor, the new service will save countless hours formerly used by counter men in answering questions and searching through cumbersome manuals for parts data, and will insure the recommendation and sale of the correct parts for each job."

Howard W. Sams, who will head the new organization, is well-known throughout the radio trade as an executive for many years with P. R. Mallory & Co., Inc., Indianapolis, Ind. For the past 15 years he has been intimately associated with the development of the Mallory-Yaxley radio parts division of that company and has taken an important part in the company's long and successful campaign for standardization of radio components.

**Electro-Voice Bulletin**

An illustrated 4-page bulletin on new Model 950 Cardax Microphone has been issued by Electro-Voice, Inc. Gives complete description, technical data, frequency response curves, specifications and application information on this new cardioid unidirectional crystal microphone. For a copy, write to the company at 1239 South Bend Ave., South Bend 24, Indiana.



*Deluxe K Series*

Newcomb now offers the first truly "post-war" amplifiers, of a quality heretofore not available to the public address field. Designed to fill a growing demand for the finest possible amplification equipment, their flawless operation signals an outstanding achievement of modern electronic research.

"Not Merely as Good as the Others  
... But Better than All Others."



Write for Information

*Standard H Series*

THE SOUND OF QUALITY

*Newcomb*  
**AUDIO PRODUCTS CO.**  
MANUFACTURERS  
DEPT. D. 2815 S. HILL STREET  
LOS ANGELES 7, CALIFORNIA

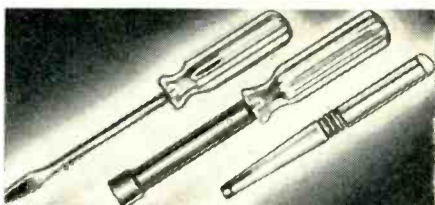

**For**

**Every  
RADIO NEED**

*there's a fine*

**VACO**

**Amberyl Plastic Handle  
SCREW DRIVER**

**to do the job better!**

**173 TYPES**

**VACO**  
**PRODUCTS CO.**

317 E. ONTARIO ST. • CHICAGO 11, ILL.  
Canadian Warehouse: 560 KING STREET, WEST • TORONTO 2, ONTARIO

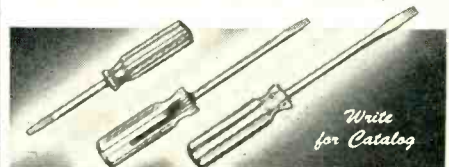

Write for Catalog

# R-L AND WARD AUTO RADIO ANTENNAS

## SIDE COWL MOUNT

5675 (as illustrated) 3 section 66". 2 stanchion mounting, rust-proof finish with 36" moisture-proof lead-in. Shipping Wt. 2 lbs. NET .....\$2.25



## UNIVERSAL FENDER MOUNT

5681 .. 3 section 56". Single stanchion mount. Fits all cars. With 48" HI-Q low loss detachable lead. Shipping Wt. 3 lbs. NET .....\$4.67

## UNIVERSAL FENDER OR COWL MOUNT

5684 — 3 section 68". Fits all cars. Shipping Wt. 2 lbs. NET .....\$3.20

Write for Free 1946 Parts Catalog



731 West Washington Blvd., Dep't. S  
Chicago 6, Illinois

# IMMEDIATE DELIVERY!

## 2-POST RECORD CHANGER



### Automatically Intermixes

Record changer completely assembled with amplifier ready to play. Dimensions 8" H. 15 1/2" x 15 1/4"D. Grilled speaker front, acoustic chamber 15"W x 4"D. with rear louvre for eliminating cabinet resonance. Genuine walnut cabinet with decal trim, nickel plated mounting hardware, tone and volume control mounted on changer 6" Heavy duty dynamic speaker. AC amplifier with power transformer. AC power cord and plug. 3 tubes 1-6V6, 1-6C5 and 1 — 5Y3. \$44.50 Net.

Cabinet less changer and amplifier \$9.50 Net. Accommodates Webster and V-M Changers.

20% Deposit required on all orders.

# UNION Radio Corporation

328 S. Paulina • Chicago 12, Ill.

## In Trade

[from page 45]

lux class, which are characterized by exceptionally brilliant and detailed pictures, together with a minimum of adjustments and maintenance.

The operating voltages for these tubes range from 1500 for the 5" tubes without the intensifier feature, to 15,000 volts for the 20" tube with intensifier.

The Type K1003P4 is of special interest to owners of prewar DuMont telesets originally equipped with a 14-inch electrostatic tube. This new 12" tube of the electrostatic type is intended as a replacement for the original 14" tube, and provides more brilliant pictures of good gradation, while the sharper trace results in considerably improved pictorial definition.

## Reopen Credit Offices

The General Electric Credit Corporation announces the opening of offices throughout the country.

Brooklyn, N. Y., 26 Court Street, under management of E. Ostrander. Indianapolis, Ind., 333 N. Pennsylvania St., R. A. Cox, manager. Pittsburgh, Pa., 717 Liberty Street, J. M. Wilson, manager. Kansas City, Mo., 105 W. 14th St., W. D. McKinley, manager. Minneapolis, Minn., 12 South 6th St., P. F. Manthey, manager. Albany, N. Y., 11 North Pearl St., W. Olesen, manager. Cincinnati, O., 617 Vine St., M. E. Davis, manager. New Orleans, La., 404 St. Charles Ave., E. S. Rockett, manager.

## Marion Catalog

Marion Electrical Instrument Company of Manchester, N. H., announces their new comprehensive 28-page catalog. It shows and describes the line of standard and hermetically sealed electrical indicating instruments, including the very latest and up-to-date developments in the instrument field.

An interesting section of this catalog is intended as a guide to prospective purchasers of electrical indicating instruments. This section incorporates detailed explanations of the factors involved in the uses of instruments in general, and points out the specific indications for certain instruments, thus assuring the buyer that he will obtain the right instrument for his equipment. The catalog further shows the development of instruments at Marion, various production procedures and the rigid tests to which the instruments are subjected during manufacture to insure the highest possible efficiency and satisfaction during use. The catalog will be sent, free of charge, upon request.

# "TAB"

That's A Buy

Complete New W.E. Oscilloscope 5 inch made by Western Electric for U. S. Army type BC412. Cost gov't over \$2000. Contains power supplies 115 v 60 cy amplifiers and controls for Vertical and Horizontal position. Focus intensity, Sensitivity, Spread, Sweep (fixed freq.) With new tubes 5BP4, 879, 5T4, Six 6L6, Two 6SJ7, 6AC7, 6HG. Easily adapted to laboratory Radio service work or television. Completely housed heavy steel case. Exceptional "TAB" price \$65. Ship. wt. cased. 200 lbs. Tested, guaranteed new.

CONDENSER tub.dual 40MFD 150WV 30 for \$7.95  
CONDENSER WE oil 16MFD 400V TWO for 2.35  
CND. SPRAGUE Gvt.Ins 15MFD 35WV 10 for .85  
COND. SPRAGUE Gvt.Ins 5MFD 35WV 20 for 1.00  
CONDENSER KIT 24 mixed oil Cornell Dub. 8 each size 1&2&3 X .05MFD 300V G.Insp. 2.40  
CONDENSER uprt.mtg oil 4MFD 600V .85  
COND. G.E. Pyr 1MFD-1000V @ .60 Ten for 5.00  
COND. G.E. Pyranol 3MFD-330VAC-1000VDC .95  
COND. AVX oil,1MFD-600WV @ .32 Five for 1.50  
COND. AVX oil,1MFD-400WV @ .30 Five for 1.35  
COND. G.E. .25MFD-1000VW @ .34 Ten for 3.00  
COND. AVX oil 1MFD-800VW @ .27 Ten for 2.45  
G.E. Neon 1/25W.NE51-105-125V Ten for .75  
CATHODE Ray tube new G'vt Insp 3P1. 6.95  
CATHODE Ray new G'insp. 5A1P1-BP1-BP4 9.95  
RCA 6AC7 new G'insp (LFS1.75) Four for .270  
TUNGOSOL min 3A4 G'insp (\$1.55) Two for 1.10  
CRYSTAL Diode 1N21&holder Two sets ea. for 1.25  
DAVEN SWITCH 13circuits,25 amp cts, Two for .98  
RELAY Sen-Sigma 5AH 200 chm 3.5 ma SPDT 2.25  
RELAY Sen W.E. 3500 chms SPDT 5A. cts. .97  
RELAY 105 Ward L. 115V60CY .20 A. cts. 1.90  
DC Voltmtr DW 41 GE 2000V-1000 ohm 2 1/2" 8.95  
DC Voltmtr 301 Weston 4000V-1000 ohm . 11.95  
DC Voltmtr 301 Weston 10,000V 1000 ohm. 12.95  
AC Voltmtr NA 33 Westghe 150V 2 1/2" B.C. 2.95  
GE DC DN1 miniature 1 ma G'insp 1 1/2" B.C. 3.25



ELECTRONIC VOLT-OHMMETER BRAND NEW U. S. ARMY TYPE 1-107-F PRECISION UNIT. Rugged design housed steel case 6"x9 1/4"x4 1/8" leather carrying handle. Contains Simpson 4" highly damped 400 microamp Alnico meter. Clear visible scale large numerals easily readable at all points. All voltage ranges ten megohms sensitivity; reads 0-3 volts in .05 v steps; 0-10 volts in .2 v steps; 0-30 volts in .5 v steps; 0-100 volts in .2 v steps; 0-300 volts in 5 v steps—OHMS Rx1 from .02 to 100 ohms; Rx10 from 2 to 1000; Rx100 from 20 to 10000; Rx1000 from 200 to 1 meg; Rx10000 from 2000 to 10 meg (center scale is 10) Unit complete with 3 test leads; batteries and instructions. Cost gov't \$65. "TAB" special \$29.70. Additional V.T. V.M. Loctal tube 1 LE 3/SP Sig C \$1.15.

DC Milliamtr One ma. 3" B case R.S. .... \$4.95  
Socket Ampheno octal S8TN mica B'ins 25 for 1.50  
Extractor Fuse Posts takes 3AG&4AG for. .98  
CRYSTAL mtd aircraft 1000KC std. 2%accy 7.95  
G.E. Switchette CR1070 C103F3 DPNOG 5 for 1.00  
MICRO-SWITCH leaf type 10A125V 3 for. .125  
MICRO-SW pin or plunger 10A SPDT 2 for. .90  
FM TELEVISION ROTABLE UHF COUPLER 3.95  
CIRCUIT Breaker HEINEMAN 30r20amp110V .97  
NEW BENDIX autosyn G'insp 110V60CY pr 18.00  
LACING cord mildew resistant 6 treated lb. 1.90  
RADIO NOISE FILTER Mallory NFI Two for .98  
TSNF. 115V60Cpri,650VCI300ma; 5V3A, 6V5A 3.95  
CHOKO Dual G.E. 30hy85ma 350 ohm G'insp 1.25  
OUNCER imp 100hy 3100 ohms Jefferson 2 for 1.25  
OHMITE 25 watt 250 or 350 ohm rheostat. 1.45  
RESISTORS 100 ass't 1/2&1W BT 50 to 2 meg. 2.50  
RES. precision W.E. Hermetically sealed 1% acy sizes 1000,5000,10000,30000 each. .25  
80000 ohm 45¢, 100000,200000 ohm each. .55  
500000 ohm 65¢, 750000 ohm 75¢, 4.5 meg. .95  
5 meg \$1.25, 12 meg 10 KV Sprague megomax. 3.60  
Spaghetti asstment 10 lengths 3" each size. .50  
KNOB Instrument 1 1/2" with pointer 5 for .90  
BAR KNOB pointer 1 1/2" inst type 5 for. .75  
KNOB assted high grade inst type 25 for. 2.50  
TUBE clamps Birtcher stainless steel 20 for 1.00

## "TAB" SPECIALS

Attenuator Daven 50000 ohm ..... 5.90  
SOCKET & Shield Miniature 3 for. 1.00  
SOCKET Diheptal C'Ray & MTG ..... 1.15  
Switch Daven 13 CKT 25A. 2 for. .98  
Switch 60amp thermostat. 1.00  
Switch DPDT-25amp AH&H 2 for. 1.48  
THERMOSTAT 85degF.15A. 3 for. 1.00  
CO-AXIAL FM-TEL CABLE 100' ..... 12.00  
ELECTRIC Plugs h'vy rubber 10 for. 1.00  
WIRE 600V Crescent # 22 std'd 1000'. 5.00  
RECTIFIER Dual Bridge meter ..... .97

\$1 Min. orders FOB NYC. Add Postage all orders and 25% deposit. Whitehall 3-3557. Send for catalog 300. Don't wait, rush orders as quantities are limited.

"TAB", Dept. R-5

Six Church Street, New York 6, N. Y.

*New!*  
*Complete!*  
**RADIO CATALOG**  
*Free!*



Mail  
Coupon for  
**FREE**  
Copy!

**RADIO SETS**  
**AMPLIFIERS**  
**RADIO PARTS**  
**ELECTRONIC EQUIPMENT**

Your copy of the complete, new Concord Catalog is ready! It offers you the greatest selection of guaranteed quality RADIO SETS, PHONORADIOS, RADIO PARTS, TEST INSTRUMENTS, BOOKS, TOOLS, AMPLIFIERS AND ACCESSORIES, AMATEUR KITS AND SUPPLIES . . . page after page of post-war-engineered equipment and parts you have long been waiting for. All standard, top-quality lines. Thousands of items. Money-saving prices. See the thrilling MULTIAMP *Add-A-Unit* Amplifiers, brand new in the field, with sensational new flexibility, fidelity and power—EXCLUSIVE with CONCORD. Your copy is ready . . . and it's FREE. Rush this coupon today.

**CONCORD**  
RADIO CORPORATION  
LAFAYETTE RADIO CORPORATION  
CHICAGO 7 ★ ATLANTA 3  
901 W. JACKSON BLVD. 265 PEACHTREE ST.

Concord Radio Corporation, Dept. K-56  
901 W. Jackson Blvd., Chicago 7, Ill.

Yes, rush FREE COPY of the comprehensive new Concord Radio Catalog.

Name .....

Address .....

City..... State.....

*Ad Index*

Aerovox Corporation .....	44
American Phenolic Corp. ....	34
B & D Distributing Co. ....	45
Burstein-Applebee Co. ....	45
Centralab .....	39
Clarostat Mfg. Company .....	44
Concord Radio Corp. ....	48
Electrical Reactance Corp. ....	38
General Cement Mfg. Co. ....	40
General Electric Co. ....	11, 43
General Industries Co., The .....	38
Hollander Radio Supply Co. ....	41
Hytron Radio & Electronics Corp. ....	12
Jensen Radio Mfg. Co. ....	31
JFD Manufacturing Co. ....	33
Lake Radio Sales Co. ....	46
Lear, Incorporated .....	1
McElroy Mfg. Co. ....	45
Meck, John Industries .....	9
Metropolitan Electronics & Instru- ment Co. ....	45
Murray Hill Books, Inc. ....	29
National Union Radio Corp. ....	Cover 3
Newcomb Audio Products Co. ....	46
Olson Radio Warehouse .....	41
Prevore Electric Mfg. Co. ....	45
Racon Electric Co. ....	10
Radio Corporation of America...Cover	4
Radio Parts Company .....	43
Radio Wire Television, Inc. ....	3
Raytheon Mfg. Corporation .....	42
Rider, John F. Publisher, Inc. ....	36
R-L Electronic Corp. ....	47
Sams, Howard W. & Co., Inc. ....	5
Shure Brothers .....	32
Simpson Electric Co. ....	2
Simpson, Mark Mfg. Co. ....	39
Snyder Manufacturing Co. ....	42
Spirling Products Co. ....	48
Sprague Electric Co. ....	27
Stewart-Warner Corp. ....	7
Sylvania Electric Products Inc. ...Cover	2
TAB .....	47
Triplett Electrical Instrument Co. ....	40
Union Radio Corp. ....	47
Vaco Products Company .....	46
Walker-Jimieson, Inc. ....	6
Waterman Products Co. ....	30
Webster-Chicago Corp. ....	37

*Spirling*  
on

**ANTENNAE**

is like  
"STERLING" on Silver  
Only "SPIRLING" has it!!  
New!!! PERMA TENSION\* telescoping

**AUTO RADIO ANTENNAE**

Our advance design guarantees unconditionally, the perfect telescoping, proper drainage and perfect contact, thus assuring highest radio reception.



"SPIRLING"  
**PHONO MOTORS**

(heavy duty)



Featuring New!!! PERMA-TENSION\*  
(Balanced Stability Operation)

Our 4 page illustrated folder describes in detail all important and exclusive features. Yours for the asking. Write for folder DS-5.

**SPIRLING PRODUCTS CO.**

60-62-64 Grand Street  
NEW YORK 13, N. Y.

\*Patents pending.





## IMMEDIATE DELIVERY for all radio service replacements

Now it's N. U. Panel Lamps, as month by month the N. U. line of quality tubes and parts grows broader . . . opens up more avenues for profitable business for service engineers. And now, you can pick up extra sales of panel lamps *by the box*. That smart looking new vest-pocket N. U. package of 10 lamps does it! Countless numbers of replacements are needed, for radios, cars, flashlights, and other uses. *Order now from your N. U. Distributor.*



NATIONAL UNION RADIO CORPORATION, NEWARK 2, N. J.



Vest-pocket box of 10 lamps—easy to sell that way—and profitable!



Complete line of types for all radio dials, panel boards, tuning meters, instruments, auto radios, flashlights, parking lights, coin machines.



The right bulb for every job—engineered to initial equipment standards—builds your reputation for accuracy and good work.



Torsion-tested filament wires . . . torque tested basing cement . . . shock and vibration tested bulbs . . . all combine to assure better service—*longer*.

# NATIONAL UNION RADIO TUBES AND PARTS

Transmitting, Cathode Ray, Receiving, Special Purpose Tubes • Condensers • Volume Controls • Photo Electric Cells • Panel Lamps • Flashlight Bulbs



# NOW . . . HERE'S HOW CUNNINGHAM CAN BOOST BUSINESS FOR YOU

YES—Cunningham is out to back you up with a host of sales and utility aids that spell more profits—because they're *time-tested*. Illustrated are but a few of the many "Big C" items proven by past performance as the top business builders for Radio Service-Dealers. They'll help you sell more

service—speed up your work—lead more customers to your shop for top quality Cunningham Electron Tubes.

You won't want to lose any time in putting these profit-pulling sales and service aids to work in your shop. So, get in touch with your Cunningham Tube Distributor *today* for full details.

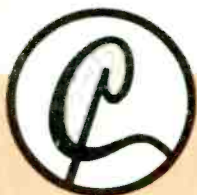

**A QUALITY PRODUCT FOR RADIO SERVICE-DEALERS  
BY THE RADIO CORPORATION OF AMERICA**